

CHAPTER 1

FUNDAMENTALS OF

COMPUTER

SHORT AND LONG QUESTIONS

Q.1 Briefly describe the working of computer processing system.

Ans: Working of Computer processing system:

A computer is a general-purpose programmable machine.

Computer:

Computer is an advanced electronic device that takes raw data as input from the user and processes it under the control of set of instructions (called program), gives the result (output), and saves it for the future use.

Function of Computer:

Computer has the ability to store, retrieve and process data. It processes data at very high speed according to the instructions given to it and produces accurate results.

Computer program:

The instructions given to a computer to perform a particular task is known as computer program. Computer processing system is shown in Fig.

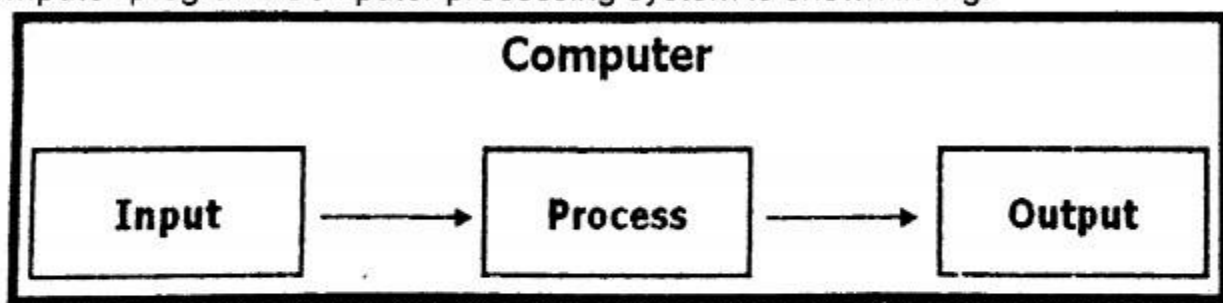

Computer processing system

Q.2 Highlight various stages in evolution of computers.

Ans: Evolution of Computer:

Evolution of computers means how the computers evolved from the first mechanical device, abacus, to electromechanical and then to the modern electronic digital computers.

Q.3 What are the tasks performed by Abacus?

Ans: Abacus:

Abacus was the earliest calculating device most probably invented in China.

Construction:

Abacus consisted of a wooden frame having parallel rods as shown in Fig.

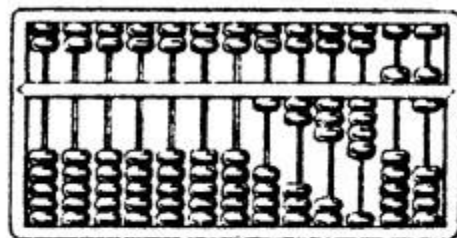
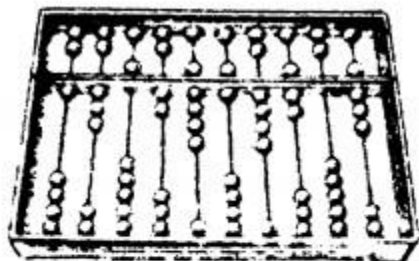

Abacus

These rods had a number of wooden beads which could slide freely along the length of rods. While performing calculations, beads were moved up and down with fingers.

Tasks performed by Abacus:

Abacus was used to perform addition, subtraction, multiplication and division. It has been used in China and some other Asian countries till the end of 20th century.

Titbits

Abacus is still seen at some toy shops, made of plastic or wood for small children.

Q.4 What are the tasks performed by Pascaline?

Ans: Pascaline:

Blaise Pascal, a French mathematician invented a calculating machine called Pascaline in 1642 when he was only 19 years old.

Construction:

Pascaline used rotating wheels. Each wheel had ten parts having digits from 0 to 9. Calculations were performed by the rotation of wheels. When one wheel completes a rotation, the next wheel moves by one digit. It had a number of small slots for displaying the result.

Tasks performed by Pascaline:

Pascaline could perform addition and subtraction on whole numbers.

Slots to display Results

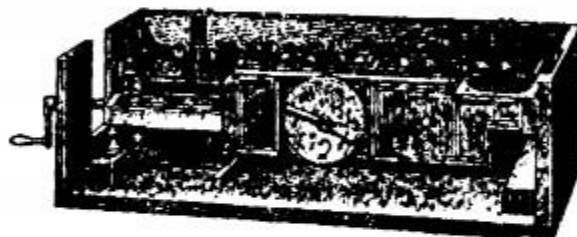
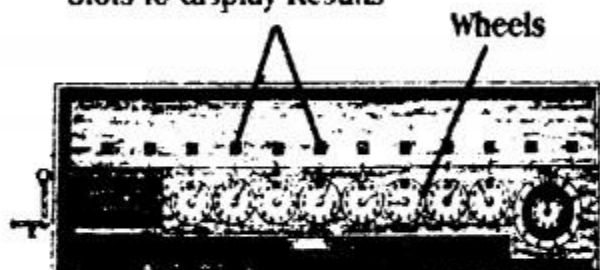

Pascaline

Q.5 Differentiate between Difference Engine and Analytical Engine.

Ans: Difference Engine:

In 1822, the English mathematician Charles Babbage started working on a big calculating machine about the size of a room. He called it Difference Engine.

Analytical Engine:

Babbage worked for many years on Difference Engine but he could not complete it. Later, he came up with idea of Analytical Engine. He could not complete it because the technology was not advanced enough but he laid the foundation stone of modern digital computers.

Today's modern digital computers are based on the idea of analytical engine.

Father of modern digital computers:

Charles Babbage is known as the father of modern digital computers.

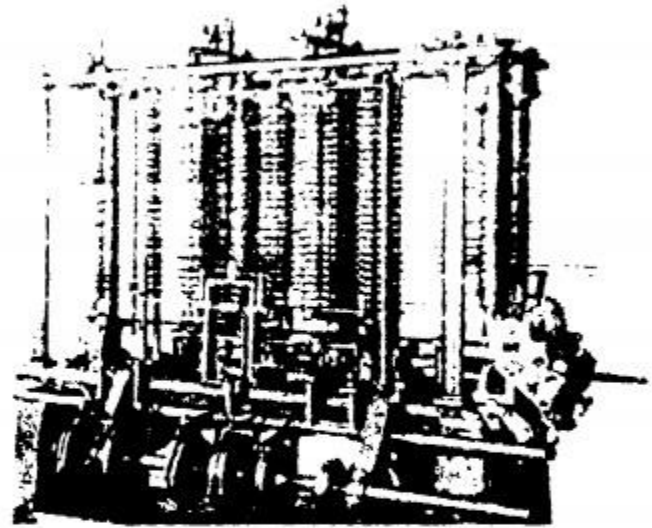
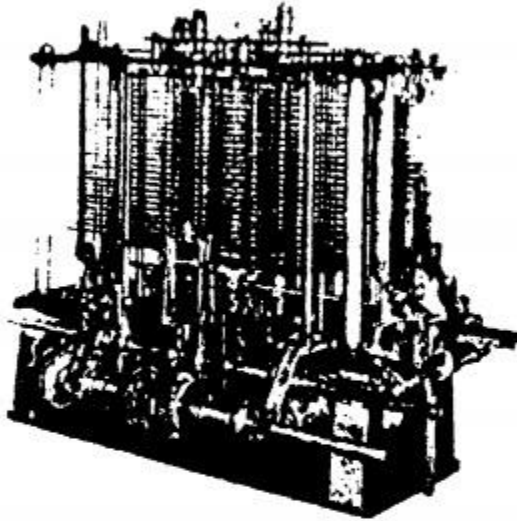

Analytical Engine

Q.6 Write a note on Hollerith desk.

Ans: Hollerith Desk:

In 1890, Herman Hollerith built a tabulating machine called Hollerith Desk. This machine was invented to help with the census of 1890 in America.

Construction:

Hollerith Desk consisted of a card reader which sensed the holes in the cards, a gear driven mechanism which could count and a large set of dial indicators to display the results.

After building Hollerith Desk, Hollerith started a company by the name of Tabulating Machine Company. Eventually this company changed its name to International Business Machines (IBM).

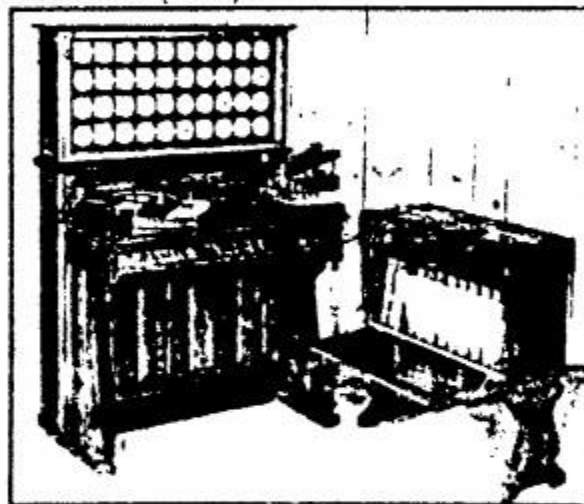

Hollerith Desk

Q.7 What are the various tasks performed by Mark-I ?

Ans. Mark-I:

The next (after the invention of Hollerith Desk) successful computing machine invented was a digital computer known as Mark-I. It was invented by Howard Aiken in 1944.

Tasks performed by Mark-I:

Mark-I could add three numbers having eight digits in one second. It could print out its results on punched cards or on an electric typewriter.

Size of Mark-I:

Mark-I was 50 feet long, 8 feet high and weighed about 5 tons.

Technology used in Mark-I:

It used 3,000 electric switches.



Mark - I Computer

Q.8 Justify the statement that computer evolution is a continuous process.

Ans: Since computer evolution is a continuous process, it has not stopped in the modern era. New systems are being developed to provide voice recognition and understand natural languages.

High performance computing (HPC):

High performance computing (HPC) is being used in today's data centers for fast data processing. High-performance computing (HPC) is the use of parallel processing for running advanced application programs efficiently, reliably and fast.

Cloud Computing:

The concept of "Cloud Computing" has been introduced. In the simplest terms, cloud computing means storing and accessing data and programs over the Internet instead of computer's hard drive.

Current advancements:

The current advancements in computer technology are likely to transform computer into intelligent machine having thinking power. The evolution of computers will probably continue till their processing capabilities have become equal to human intelligence or even beyond that.

Q.9 List history and generations of computer.

Ans: History and Generations of Computer:

History of computers is a chain that runs from the ancient abacus and the analytical engine of the nineteenth century, through the modern computers of present age. It is generally divided into five generations. Each generation of computers is characterized by major technological developments of that time.

Q.10 Write a short note on the second generation of computer and the technology used in it. Also write down the names of model used in second generation of computers?

OR

Write a note on invention of transistor and second-generation of computers?

Ans: Second Generation Computers (1956 – 1963):

In 1947, three scientists, William Shockley, John Bardeen and Walter Brattain invented transistor.

Transistor:

Transistor functions like a vacuum tube. It replaced the vacuum tubes in the second generation computers. Transistor was faster, more reliable, smaller and much cheaper than vacuum tube.

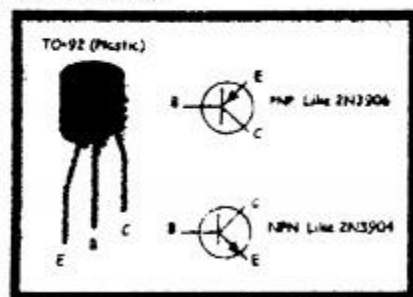

Transistor

Characteristics/Features of second generation computers:

The following are the characteristics of second generation computers.

- i. Transistors were used instead of vacuum tubes.
- ii. Transistors reduced the size of computers and increased the speed and memory capacity.
- iii. Computers became more reliable and cheaper.
- iv. Second generation computers used punch card readers, magnetic tapes, magnetic disks and printers.
- v. Assembly language was used in these computers.
- vi. High level programming languages, FORTRAN and COBOL were introduced in this generation of computers.

Models/examples:

Examples of second generation computers are UNIVAC II, IBM 7030, 7780 and 7090, NCR 300 series, General Electric GE 635 and Control Data Corporation's CDC 1604 computers.

Q.11 Write a short note on the Fourth generation of computer and the technology used in it. Also write down the names of model used in Fourth generation of computers?

OR

Write a note on invention of Microprocessor and Fourth -generation of computers?

Ans: Fourth Generation Computers (1971 – Present):

In this generation of computers LSI (Large Scale Integration) and VLSI (Very Large Scale Integration) chips having millions of transistors were developed.

Microprocessor was also developed in fourth generation of computers. A microprocessor is a single chip that can handle all the processing of a computer. A microprocessor is shown in Fig.

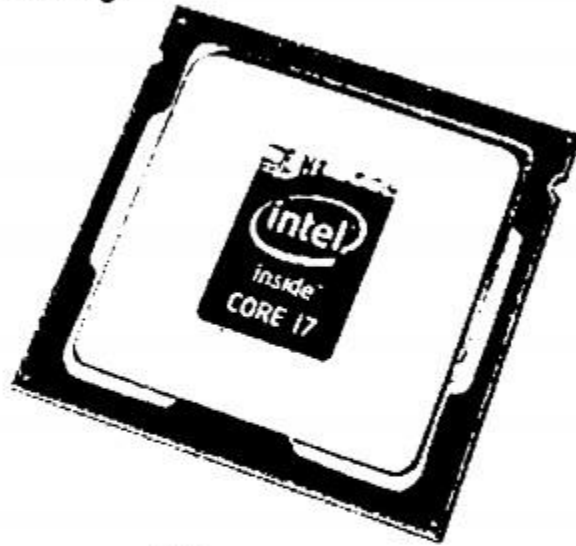

Microprocessor

Characteristics/features of fourth generation computers:

The following are the characteristics of fourth generation of computers.

- i. Microprocessor was developed which resulted in the development of microcomputers.
- ii. Fourth generation computers are very fast, have large storage capacity and use advanced input/output devices.
- iii. Microcomputers are very small in size, very reliable, consume less power and are affordable.
- iv. Large variety of software is available for use in microcomputers.
- v. Operating system having Graphical User Interface (GUI) was developed in this generation.
- vi. These computers support multimedia software that combines text, image, sound and video.
- vii. These computers support modern programming languages such as Visual Basic, C++, Java and Python for developing powerful software.
- viii. Fourth generation computers support a large variety of portable and wireless input/output devices.

Examples of microprocessors:

Some examples of microprocessors developed in fourth generation of computers are Intel Pentium series, Dual Core, Core2 Duo, Core i3, i5, i7 and AMD Athlon.

Examples of fourth generation computers:

Some examples of fourth generation computers are IBM Think Pad series, HP Pavilion series, Dell Inspiron series and Apple's MacBook Pro and MacBook Air series.

Do You Know?

Intel invented the world's first microprocessor, the Intel 4004 in November, 1971.

Q.12 Write a short note on the fifth generation of computer and the technology used in it. Also write down the names of model used in fifth generation of computers?

OR

Write a note on Artificial Intelligence and fifth -generation of computers?

Ans: Fifth Generation Computers:

The goal of fifth generation of computers is to develop devices that can understand natural languages and have thinking power. This is a big challenge for computer developers and programmers to design such systems and software for them

Characteristics/features of fifth generation computers:

The following are the characteristics of fifth generation of computers.

- i. Fifth generation computers are based on Artificial Intelligence (AI).
- ii. In the fifth generation of computers, Artificial Intelligence (AI) will minimize the need to write programs.
- iii. These computers will allow users to give commands in any natural language such as English.

Examples of fifth generation computers:

Examples of fifth generation computers are robots and expert systems.

For Your Information

Artificial Intelligence is the branch of computer science concerned with making computer behave like humans.

Q.13 List the TYPES/classification OF COMPUTERS.

Ans: Types of Computers:

On the basis of data representation, processing, Input and Output, Computers can be classified into the following three types.

- i. Analog Computers
- ii. Digital Computers
- iii. Hybrid Computers

Q.14 Describe some of the features of Hybrid Computers/ Vital Sign Monitoring Unit.

Ans: Hybrid Computers/Vital Sign Monitoring Unit:

Hybrid computers are the combination of analog and digital computers. They combine the characteristics of both analog and digital computers.

Uses of Hybrid Computers:

Hybrid computers are mainly used for scientific applications. These computers are used in spaceships, missile systems, scientific research, hospitals and for controlling industrial processes.

Vital Sign Monitoring Unit:

A hybrid computer known as Vital Sign Monitoring Unit is shown in Fig. It is used in hospitals to monitor patient's important data such as blood pressure, temperature, respiration and heartbeat.

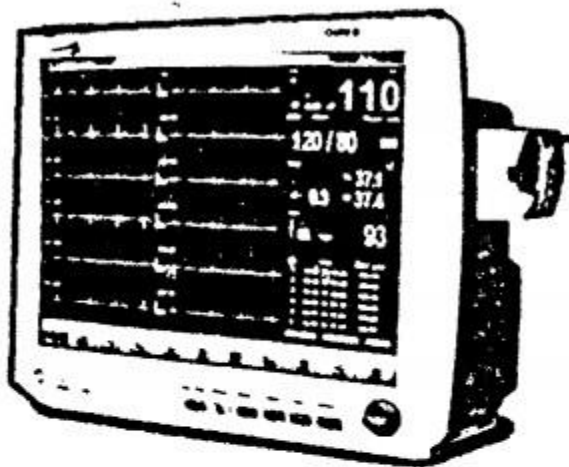

A Hybrid Computer (Vital Sign Monitoring Unit)

Q.15 List the classification of digital computers.

Ans: Classification of Digital Computers:

Digital computers are classified into mainframe, minicomputer and microcomputer based on their size, speed, storage capacity and the number of users they can support.

Q.16 List the use/Role of computers in education.

Ans: Education:

Role of computers in education has been given a lot of importance in the recent years. Computer technology eases the process of learning. Many programs are available for students to learn the subjects of Physics, Mathematics, Chemistry, Biology, etc.

Multimedia software makes the process of learning interactive and interesting. It combines text, graphics, sound and video for effective learning. Internet has enormous information on a wide variety of subjects. Students can refer to Internet to find information on any topic.

Multimedia projectors:

Nowadays computers with multimedia projectors are being used in classrooms for effective teaching. All the activities related to examinations are also being controlled using computers. Therefore, it plays an important role in education. Today, computer education is a part of curricula from elementary to university level.

Q.17 Discuss the use/Role of computers in education.

Ans: Business:

Computers are used in all types of businesses, to improve productivity. They help in running business activities efficiently. They are used to prepare business documents, reports, charts, presentations, invoices, etc. They help in staying in contact with employees and customers.

Important business areas where computers are used:

The following are some important business areas where computers are used.

- i. Computer technology has revolutionized the banking business. Deposits and withdrawals are instantly logged into a customer's account.
- ii. Accurate monthly bank statements are generated with the help of computer. Computer networks allow amount of bill to be transferred from customer's bank account to the store.

iii. Automated Teller Machine (ATM):

People can obtain cash any time anywhere through Automated Teller Machine (ATM)

iv. Bar code readers:

Computers are used in retail stores. Bar code readers are linked to computer system that are used to read the bar code printed on each product sold to prepare the bill. With the use of computers at retail stores, the checkout process is faster and the bill produced is accurate.

v. Electronic commerce/E-Commerce:

Electronic commerce, also known as e-commerce allows to sell products and services by means of computer networks such as Internet.

vi. Computers are very helpful in running many other types of businesses that include hotel, hospital, school, travel agency, real estate, stock exchange, etc.

Q.18 List the Use/Role of Computers in Defense.

Ans: Use/Role of computers in defense:

There are various applications of computer technology in defense. Computers are used in tanks, planes and ships to target enemy forces. They help in tracking missiles and destroying them. Modern defense weapons and other equipment are controlled by computers.

Computers are used for designing and testing of weapons. Computers are also used in communication systems in defense.

Q.19 List the Use/Role of Computers in Media.

Ans: Use/Role of Computers in Media:

Computers have lot of applications in print and electronic media. Print media refers to mass communication through printed material.

Computer technology helps in preparation and production of newspapers, magazines, booklets and brochures, flyers, press releases and books.

Electronic media refers to broadcast media that includes radio broadcast, cable and satellite television broadcast and the new-age media like Internet and mobile devices. Computer is used for television broadcasting.

Q.20 List the Use/Role of Computers in Manufacturing Industry.

Ans: Use/Role of computers in manufacturing industry:

Now days, computer technology is widely used in manufacturing industry. It has improved the accuracy, quality and speed of manufacturing.

Computers are used for product design and automation of manufacturing process in factories. This is known as Computer-Aided Design (CAD) and Computer-Aided Manufacturing (CAM).

Computer-Aided Design (CAD):

CAD involves the use of computer hardware and graphics software to create product designs.

Computer-Aided Manufacturing (CAM):

CAM involves the use of computer in planning and management of production operation. It helps in automatically producing finished products. CAD/CAM technology has been applied in many industries, including automobile, electronics, machine components, textiles, fashion, etc.

Q.21 Elaborate the scope of the careers in the field of information technology.

Ans: Careers in Information Technology (IT):

Software Engineer:

Software engineer is a highly skilled person in the field of IT whose responsibilities involve the analysis, design, implementation and maintenance of computer software. Software engineer can be further classified into programmer and system analyst.

- **Programmer:**

Computer programmers are IT professionals who have extensive knowledge and expertise in programming languages. They program the computer by writing step-by-step instructions that tell the computer what to do. Computer programmers write programs to solve problems related with business, education, engineering, government offices, hospitals, entertainment, etc.

- **System Analyst:**

System analysts analyze the data processing requirements of organizations and develop information systems to implement them. They investigate problems, plan solutions, and recommend the type of hardware and software required for implementing the solution. They also coordinate with the programmers and database administrators in developing information systems.

Hardware Engineer:

Hardware engineers design and manufacture computer hardware. Their work also involves repair and maintenance of computer hardware. They have in-depth knowledge of internal working of computers, processors, circuit boards and other electronic equipment.

Network Administrator:

Network administrators are responsible for installation, configuration and maintenance of computer networks in organizations. They are in charge of maintenance of computer hardware and software that make up a computer network. They assign passwords to network users so that unauthorized people do not have access to network.

Database Administrator:

Database administrator is a person who is responsible for the design, implementation and maintenance of a database in an organization. He is also responsible for maintaining security and monitoring the performance of database.

Web Designer:

Web designer is a person whose job is to plan and create websites. He designs web pages that include text, images, sound, video clips and make the website interactive. HTML (Hypertext Markup Language) is the most commonly used language for creating websites.

Multimedia Designer:

Multimedia designers are people who organize and present information in an easy to understand and attractive manner. They combine text, graphics, animation, audio and video. Multimedia designers create digital images and arrange them in sequence for animation using computer software. They have the skills to edit and manipulate audio/video files. They usually work in film/TV industry, computer software companies and advertising companies.

Information Security Analyst:

Information security analyst is a person whose job is to protect information and information systems from unauthorized access, use, modification, recording or destruction. He implements procedures and policies to ensure information security within the organization.

Computer Teacher:

Computer teacher teaches the subject of computer science to students to make them computer literate. He conducts lessons on how to operate computers and the working principles and concepts of computer hardware. He also teaches how to develop computer programs using various programming languages.

Q.22 Define Computer.

Ans: Computer:

A computer is an electronic data processing device. It reads data processing it and produces results accurately at a very high speed.

Q.23 Define Computer system.

Ans: Computer system:

A computer along with a number of units attached to it (such as keyboard, monitor, disk drives etc) is known as a computer system.

Q.24 Differentiate between hardware and software of a computer.

Ans: Difference between computer hardware and software:

Hardware:

Hardware is a physical device something that you're able to touch and see. Computer hardware refers to the physical components that make up a computer system.

Example:

The computer monitor you're viewing the text on or the mouse you're using to navigate is considered computer hardware. RAM, ROM, motherboard, modem, wireless chip, CPU/Hard Disk etc.

Software:

Computer software is a set of instructions that tells a computer what to do and how to do.

Software is code and instructions that tell a computer or hardware how to operate. This code can be viewed and executed using a computer or other hardware device.

However, without any hardware software would not exist.

Example:

An example of software is Microsoft Windows, an operating system that allows you to control your computer and other programs that run on it.

Another example of software is the Internet browser. Operating system (Windows, Linux) games or applications, word processing /Internet Explorer or Firefox etc. are the examples of software.

Q.25 Write the names of three major units of computer system?

Ans: Major units of computer system:

Generally a computer system consists of the following three major units:

- i. **System unit**
- ii. **Input units** (A keyboard, mouse etc.)

iii. Output units (A monitor, printer etc.)

Q.26 Write the names of hardware components of a computer system?

Ans: Hardware Components of Computer:

Hardware components of a computer system are classified into input devices, system unit, storage devices, output devices and memory.

Q.27 What is the function of input devices.

Ans. Input devices:

All the devices used to feed data into the computer are known as input devices

Function of input devices:

Input devices allow us to communicate with the computer.

Examples:

Some commonly used input devices are keyboard, mouse, microphone, scanner, barcode reader, digital camera and touch screen.

Q.28 Describe the division of keyboard and its functions?

Ans: Keyboard:

It is the main input device to communicate with the computer.

Division of a Keyboard:

It allows the computer user to enter letters, numbers and special symbols into the computer.

Functions of a Keyboard:

A keyboard may be divided into four general areas:-

- i. Alphanumeric keypad.
- ii. Numeric keypad.
- iii. Function keypad.
- iv. Screen Navigation & Editing keys



A Standard Keyboard

Point To Ponder

Why the keys on keyboard are not arranged in alphabetical order?

Ans: In fact, the QWERTY layout was designed to let people type as quickly as possible without jamming a mechanical typewriter. As it happens, this same layout is nearly optimal for pure speed, as it tends to cause the fingers and hands to alternate.

OR (Second Answer)

The QWERTY keyboard layout was designed so that successive keystrokes would alternate sides of the keyboard so as to avoid jams in manual typewriters. It is frequently said that the design was also created to make people type slower.

First designs of manual typewriters using keyboards with letters on alphabetical order could not keep up with the speed of fast typist and the QWERTY keyboard layout was designed to reduce jamming.

Q.29 Describe the working and functions of mouse?

Ans: Mouse:

It is a hand-held device used to control the movement of cursor or pointer on the screen. It has two or three buttons at the front that allows the computer user to make selection in menu, draw graphics or open files, folders and programs. A mouse is shown in Fig.

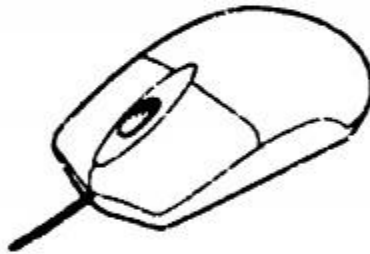

Mouse

Q.30 Describe the working and functions of microphone?

Ans: Microphone:

It is a device that allows computer user to input audio into the computer.

It changes audio signals into electrical signals which are translated into digital form by the sound card for processing in the computer. A microphone is shown in Fig.



Q.31 Describe the working and functions of scanner?

Ans: Scanner:

It is a device that captures images from photographs, magazines, books etc. and stores them in computer in digital form. These images can be edited, displayed on the screen or inserted in documents. A scanner is shown in Fig.



Scanner

Q.32 Describe the working and functions of barcode reader?

Ans: Barcode Reader:

It is a device that reads the barcode printed on products that represents product code, description and price. This information is used by the computer to print bill for the customer. A barcode reader is shown in Fig.



Barcode Reader

Q.33 Highlight the working and functions of digital camera.

Ans: Digital Camera:

It is a device used to capture pictures and store them in digital form.

These pictures can be downloaded to computer for editing, viewing or inserting in documents. A digital camera is shown in Fig.



Digital Camera

Q.34 Highlight the working and functions of touch screen.

Ans: Touch Screen:

It is a pressure-sensitive display screen that is used to interact with the computer by touching pictures or words with finger. Touch screen is more commonly used with mobile phone and tablet. A touch screen is shown in Fig.

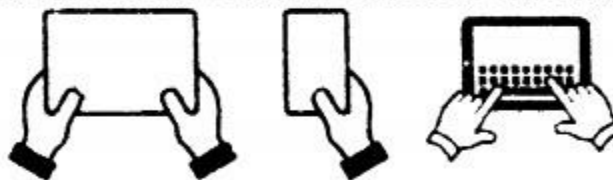

Touch Screen

Q.35 Write the names of three major parts of SYSTEM UNIT ?

Ans: System Unit:

System unit is the main part of computer. It includes motherboard, power supply and drives (such as DVD and hard disk) inside the computer casing. All the input/output devices of a computer are connected to system unit through the ports.

Q.36 Describe the working and structure of motherboard.

Ans. Motherboard:

Motherboard is the main circuit board inside the system unit. It contains microprocessor, main memory, expansion cards, many IC chips, connectors and other electronic components.

It has many buses (electric pathways) printed on it. These are used to transmit information between various components of the computer. All the input/output devices are connected to the motherboard. A motherboard is shown in Fig.

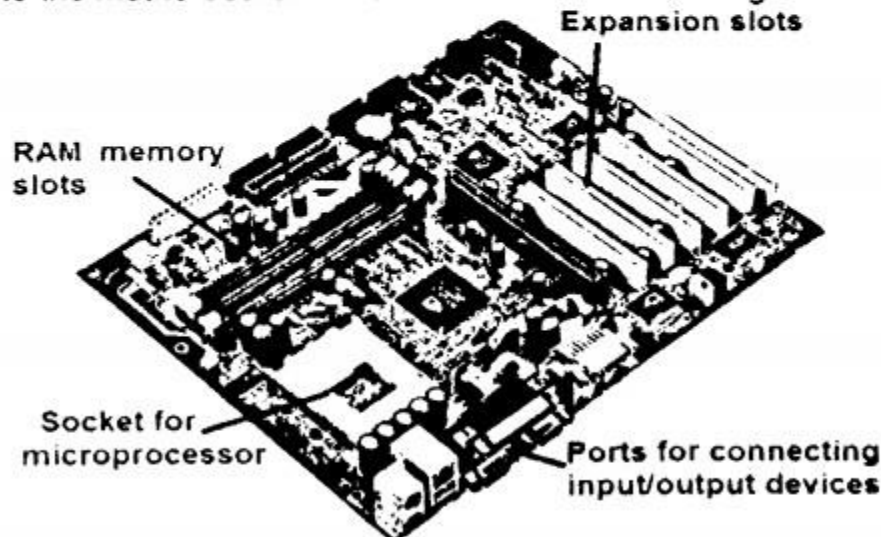

Motherboard

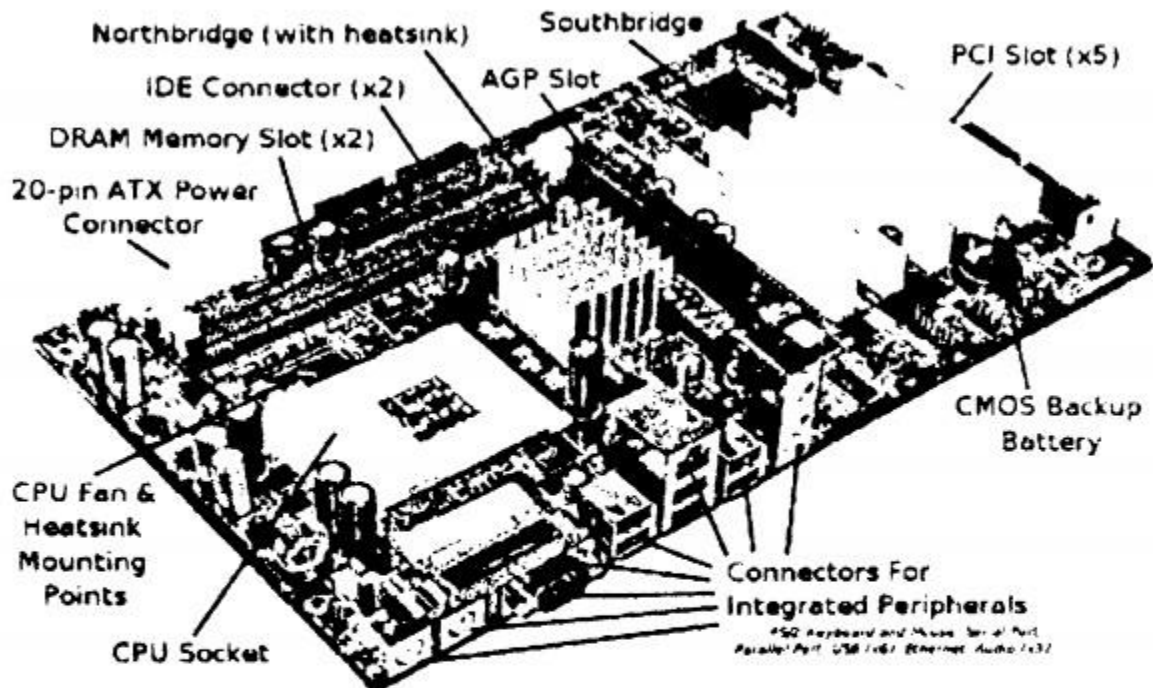

Q.37 Describe the working and structure of Microprocessor.

Ans: Microprocessor:

A microprocessor is the main chip on the motherboard that controls all the activities of the computer. It is also known as Central Processing Unit (CPU) or simply processor.

It contains Control Unit (CU), Arithmetic Logic Unit (ALU) and registers. A microprocessor and the block diagram of CPU are shown in Fig.

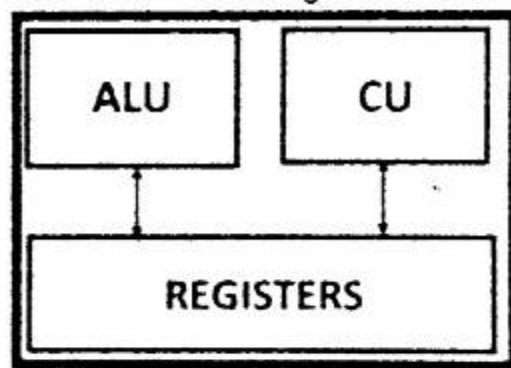
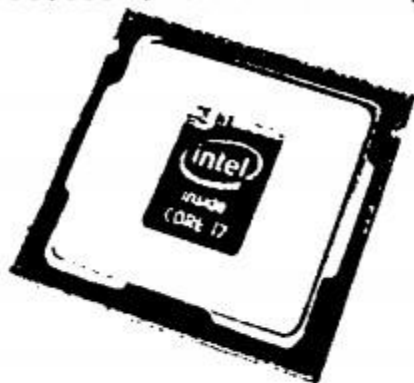

(a) Microprocessor (b) Block diagram of microprocessor

ALU:

ALU is the part of the computer that performs all the calculations and comparisons. It consists of arithmetic unit and logic unit.

Arithmetic Unit:

Arithmetic unit performs all the arithmetic operations such as addition, subtraction, multiplication and division.

Logic Unit:

Logic unit performs logical operations which include comparisons of numbers or alphabets.

Functions of Control Unit:

Control unit controls the operations of all the components of the computer. It controls the working of all the input/output devices, storage devices and ALU. CU

loads programs into memory and executes them. It consists of very complicated circuits.

Q.38 Briefly write about Registers.

Ans: Registers:

Registers are small memory units inside the microprocessor used to temporarily store some information during the execution of a program. Some commonly used registers are Instruction Register, Accumulator Register, Data Register and Memory Address Register.

Q.39 Briefly write about storage devices.

Ans: Storage Devices:

Storage devices are used to store programs and data that are not currently used by the computer. They have huge storage capacity. Therefore, they are also known as mass storage devices or secondary memory.

Hard disk is the most commonly used storage device that is fixed inside the system unit. Portable storage devices are CD, DVD, memory cards and USB flash drive.

Portable storage devices have less storage capacity than hard disk but they are cheap and easy to carry.

Q.40 Briefly write about hard disk.

Ans: Hard disk:

A hard disk is a magnetic storage device used to store computer data. It has storage capacity of hundreds of Gigabyte (GB). It is fixed inside the computer casing. Portable hard disk is also available that is attached to USB port.

Q.41 Briefly write about CD/Compact Disk.

Ans: CD/ Compact Disk:

CD stands for Compact Disk. It is a portable optical storage device with a storage capacity of 700 Megabytes (MB). A CD is 1.2 millimeter thick with a diameter of 120 millimeters. CD drive is used to read data from or write data to a CD.

Q.42 Briefly write about DVD/Digital Versatile Disk.

Ans: DVD/ Digital Versatile Disk:

DVD stands for Digital Versatile Disk. It has the same thickness and diameter as CD but has more storage capacity. Its storage capacity is in the range of 4 to 16 GB. A DVD writer is installed in the computer to read data from or write data to a DVD. A CD can also be used in a DVD writer.

Q.43 Briefly write about Memory Card.

Ans: Memory Card:

Memory card is a small storage device having storage capacity of few Gigabytes. It is available in different sizes and storage capacities.



Memory cards are generally used in laptop computers and portable devices such as mobile phone and digital camera for storing pictures, audio and video. A memory card is shown in Fig..

Q.44 Briefly write about USB flash drive.

Ans: USB Flash Drive/USB memory:

USB flash drive is a small portable drive that is connected to computer through USB port. It is also known as USB memory.

It is very fast in operation and its storage capacity is up to 128 GB till now. A USB flash drive is shown in Fig.



USB flash drive

Q.45 Write about the significance of output devices.

Ans: Output Devices:

Output devices are used to display text, graphics and images on the monitor or to print information on paper.

Softcopy and hardcopy/printout:

Information displayed on monitor is known as softcopy and anything printed on paper is known as hardcopy or printout.

Commonly used output devices are monitor, printer, plotter and speaker.

Q.46 Describe some features of different types of monitors.

Ans: Monitor:

It is an output device that has a screen on which information is displayed

Types of Monitor:

It has two common types i.e. CRT (Cathode Ray Tube) monitor and LCD (Liquid Crystal Display) monitor.

CRT monitor:

CRT monitor is very similar to old television. It is almost obsolete due to its big size and low display quality.

LCD monitor:

LCD monitor is slim, uses less power and has better display quality than CRT monitor. CRT and LCD monitors are shown in Fig.

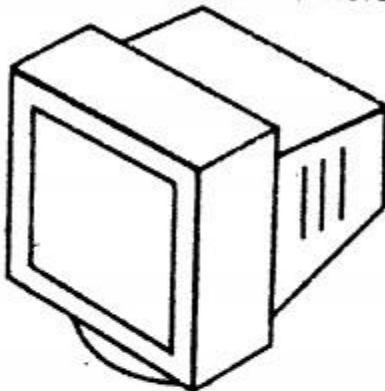

(a) CRT Monitor



(b) LCD Monitor

Q.47 What is printer. Write name of different types of printers.

Ans: Printer:

Printer is an output device that prints text and graphics on paper which is known as hardcopy.

Types printers:

There are two types of printers which are impact and non-impact printers.

For Your Information

The first high-speed printer was developed in 1953 by Remington Rand (an early American business machines manufacturer) for use on UNIVAC computer.

Q.48 What is an impact printer? How does it work? Describe the different features of Dot matrix printer.

Ans: Impact Printer:

Impact printer uses electro-mechanical mechanism which causes the character shape to strike against the paper and leave an image of the character on the paper

Features of Dot matrix printer:

Dot matrix printer is the most commonly used impact printer. The printing speed varies from 50 to 500 cps (characters per second).

Their printing is very cheap but print quality is poor. They produce lot of noise while printing.

Uses of Dot matrix printer:

These printers are still in use for printing invoices, bank statements, utility bills, etc. A Dot matrix printer is shown in Fig.

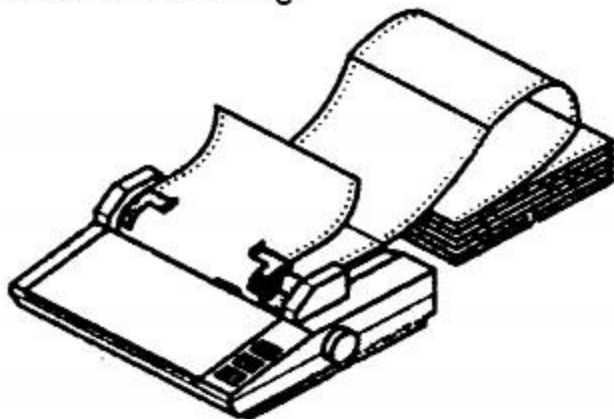

Dot Matrix Printer

Q.49 What is a non- impact printer? How does it work? Describe the different features of non-impact printer.

Ans: Non-Impact printer:

Non-Impact printer prints without striking the paper.

Types of non-Impact printers:

There are two types of non-Impact printers which are inkjet and laser printers.

Inkjet and laser printers:

Inkjet printer stores ink in cartridge and sprays on paper through fine nozzles on the print-head.

Inkjet and laser printers:

Laser printer uses technology similar to photocopying machine. Laser printer is more expensive, faster and has very high print quality compared to inkjet printer.

Inkjet printers are used in all sectors such as homes and simple businesses. Laser printers are perfect for large scale businesses. Inkjet and laser printers are shown in Fig (a. b).



(a) Inkjet Printer



(b) Laser Printer

Q.50 What is a plotter? How does it work? Describe the different types of plotters.

Ans: Plotter:

Plotter is an output device used for printing engineering drawings, machine parts, building designs, maps, charts and panaflexes etc. on large size papers/sheets.

Such large size printing is not possible on printers. It is more expensive than printer

Types of plotters:

There are two types of plotters, that is, ink plotter and pen plotter

Uses of plotters:

Ink plotter is used for printing images whereas pen plotter is used for printing engineering drawings, machine parts, building designs, etc. Plotter is a slow output device but its printing quality is good.

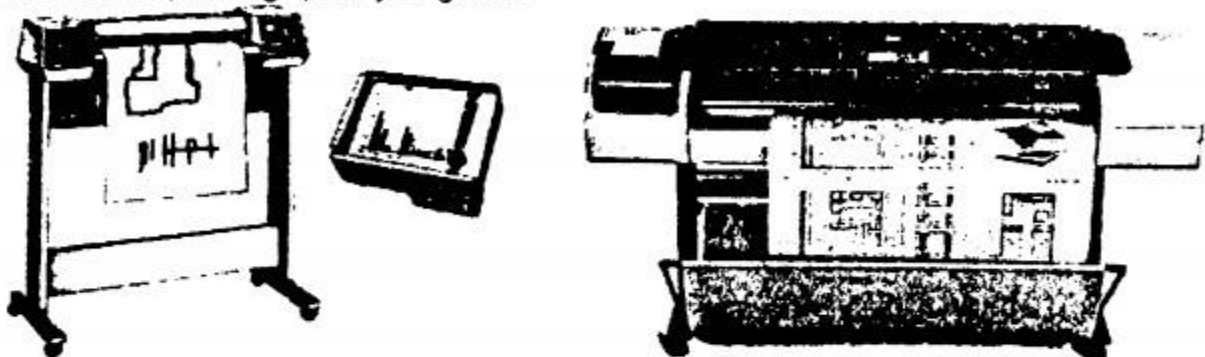

Plotter

Q.51 Describe some features of Speaker.

Ans: Speaker:

Speaker is a device used to produce audio output. A pair of speakers is attached to the sound card on the mot' erboard.

Speakers are commonly used with multimedia software and for playing music and videos on computer.

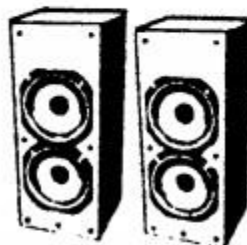

Speaker

Q.52 List some functions of memory.

Ans: Memory:

Memory unit stores data and programs that are being executed by the computer. It also stores the results produced by the ALU after processing the data.

Types of memories:

There are three types of memories on the motherboard which are ROM (Read Only Memory), RAM (Random Access Memory) and Cache.

These are known as main memory or primary memory of computer.

Q.53 What is ROM? How do PROM and EPROM differ from each other?

Ans: ROM (Read Only Memory):

ROM is a single IC chip which is installed on the motherboard.

Types of memories:

It stores the Basic Input/output System (BIOS) of computer that controls input/output devices and the start-up or boot process.

BIOS programs:

BIOS programs test the computer's components when it is turned on and then load the operating system into the RAM to make the computer ready for operation.

BIOS programs are permanently stored in ROM when it is manufactured.

ROM is non-volatile memory:

ROM is non-volatile memory, that is, the programs stored in it are not lost when the computer is turned off.

Types of ROM:

There are three common types of ROM which are:

- i. **PROM** (Programmable ROM),
- ii. **EPROM** (Erasable Programmable ROM)
- iii. **EEPROM** (Electrically Erasable Programmable ROM).

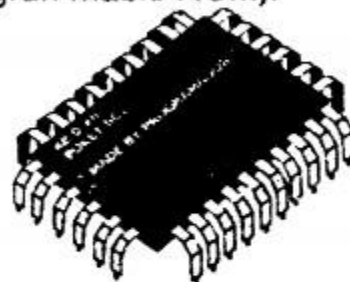
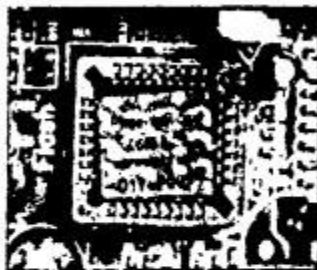

ROM Chip

Difference between PROM and EPROM:

PROM (Programmable Read Only Memory)	EPROM (Erasable and programmable Read Only Memory)
i. PROM is a non-permanent memory of a computer. It is programmable read only memory.	i. EPROM is a non-permanent memory of a computer. It is programmable and erasable read only memory.
ii. PROM is the Programmable ROM that allows the user to store data an instrument called a PROM programmer does the storing by 'burning in', once the data has been burned, the data cannot be erased.	ii. EPROM (Electronic Programmable Read Only Memory) chips can be erased if it needs to be updated or fixed. It can be erased electronically only These are comparatively expensive than PROMs.

iii. PROM (Programmable Read Only Memory) chips are relatively once written and to rewrite then you need to replace entire data on it. These are relatively less costly.

iii. On the other hand, an EPROM allows the data to be erased by the help of uv (Ultra violet) lights. i.e. EPROM is uv light erasable and electrically reprogrammable.

Q.54 What do you know about RAM?

Ans: Random Access Memory (RAM):

RAM is high speed memory installed on the motherboard. It is READ/WRITE memory. Information can be read from or written into it. Programs are loaded into RAM from secondary storage devices such as hard disk or USB flash drive for execution by the microprocessor.

Volatile memory:

RAM is volatile memory which means information stored in it, is lost when the computer is turned off.

RAM modules are installed in the memory slots on the motherboard. RAM modules are shown in Fig.

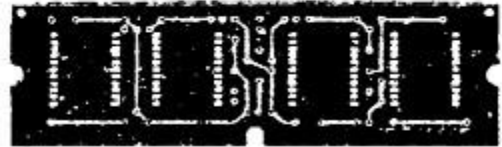

RAM Modules

Q.55 Describe various features of Cache Memory?

Ans: Cache Memory:

Cache is a very small amount of extremely fast memory inside the microprocessor or on the motherboard. It is faster and more expensive than RAM.

Function of cache:

Cache Memory stores information that is most frequently used by the computer.

Purpose of using cache:

The purpose of using cache is to improve the processing speed of computer.

Types of cache memories:

There are three types of cache memories which are: Level 1(L1), Level 2(L2) and Level 3(L3) as shown in Fig.

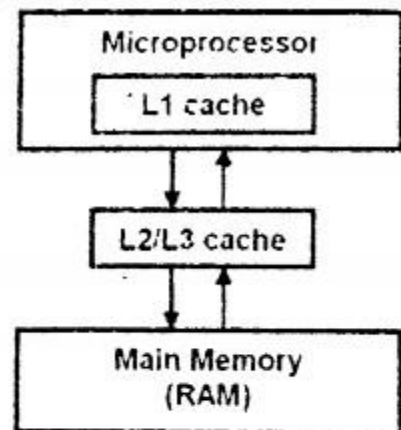

L1, L2 and L3 Cache Memories

Location of Level 1(L1), Level 2(L2) and Level 3(L3):

L1 cache is built inside the microprocessor whereas L2 and L3 are on the motherboard.

Note: L1 cache is faster than L2 and L3 cache.

Q.56 Describe the function of ports in a computer. How many types of ports are generally present in a computer system?

Ans. Ports:

Port is an interface for connecting various devices to the system unit. These are located on the motherboard and are usually seen at the back of the system unit.

Function of Port:

A port provides a direct link for external peripheral devices such as keyboard, mouse, monitor, printer etc via cables with the computer's common electrical bus.

Types of ports:

There are various types of ports for connecting keyboard, mouse, monitor, microphone, speakers and other input/output devices as shown in Fig.

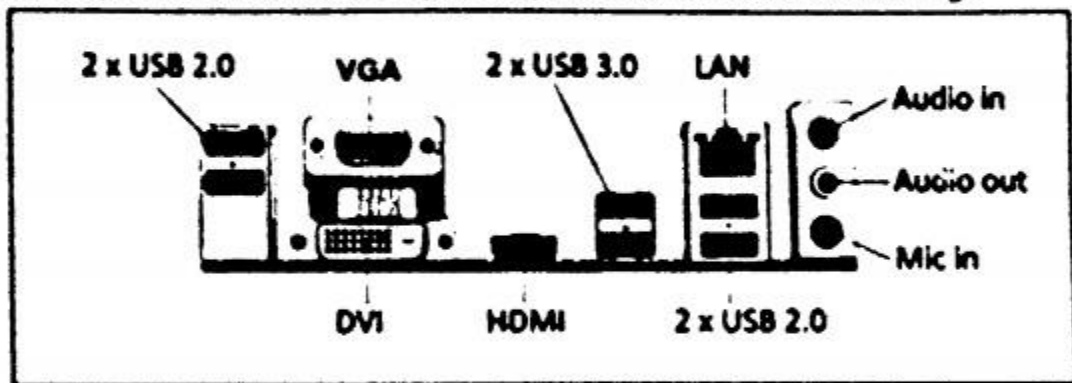

Ports on motherboard

In modern computers:

- USB (Universal Serial Bus),
- HDMI (High Definition Multimedia Interface),
- DVI (Digital Visual Interface),
- Audio and LAN (Local Area Network) ports

are used for connecting various devices to the computer. These devices include digital camera, scanner, printer, external hard disk or DVD writer and USB memory, etc

Q.57 Describe the function of expansion slots and expansion cards in a computer.

Ans: Expansion Slots:

Expansion slots are long narrow sockets on the motherboard used for installing expansion cards.

Expansion Cards:

Expansion cards are small circuit boards. These cards add new capabilities to the computers.

Commonly used expansion cards are sound card, graphics card, modem card and network card. In modern computers these cards are built-in on the motherboard. A network card is shown in Fig.

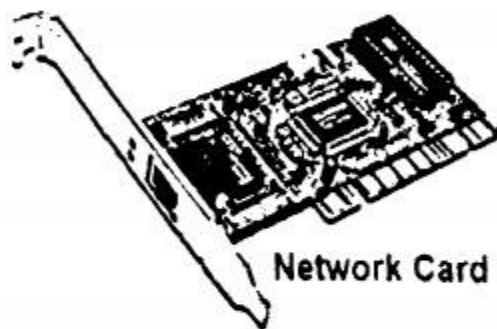

Q.58 What is computer software? List the main groups of computer software?

Ans. Computer Software:

Computer programs are known as computer software. Computer program is a set of instructions that tells a computer what to do and how to do.

Types computer Software:

It is classified into two categories, system software and application software.

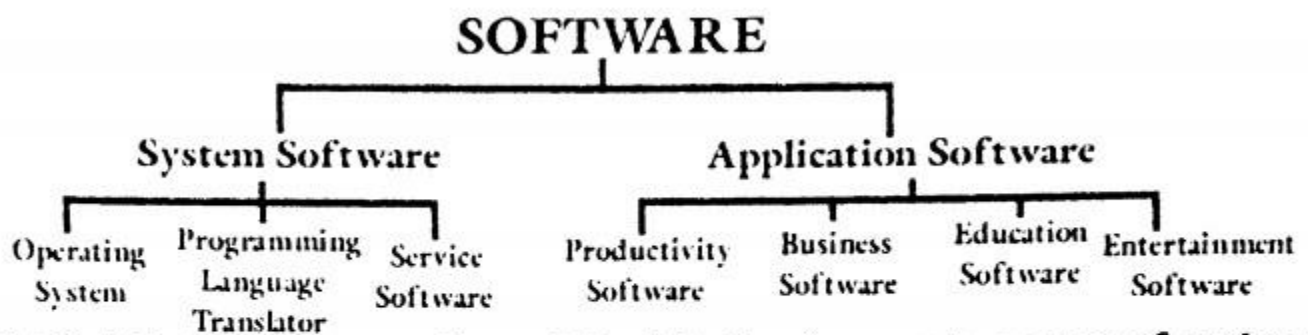

Q.59 What is system software? Explain the four main groups of system software?

Ans. System Software:

System software is a collection of programs which makes the use of computer easy and efficient. Highly experienced computer programmers develop system software.

Main groups of system software:

Following are the types of system software.

- Operating system
- Utility programs
- Device drivers
- Language processors

i. Operating System:

An operating system is system software that is responsible for the management and coordination of all the activities performed by the computer.

It provides the environment in which the user can interact with the computer hardware to operate the computer.

The most popular operating system used in microcomputers is the Windows.

Tasks performed by the operating system:

The following tasks are performed by the operating system.

- i. It loads programs into memory and executes them.
- ii. It controls the operation of input/output and storage devices.
- iii. It manages files and folders.
- iv. It allows to create password to protect computers from unauthorized use.
- v. It detects hardware failures and displays messages to fix them.

ii. Device Drivers:

A device driver is system software that controls the operation of a computer device.

When users attach a device such as printer or scanner to their computer, they should install its driver also to make it operational. Device drivers are provided by device manufacturers.

iii. Utility Programs:

Utility programs perform specific tasks that are related to the management of the computer.

Commonly used utility programs:

The following are some commonly used utility programs that perform specific tasks.

Windows Explorer: It is used to manage files and folders.

Backup utility: It is used to make backup of data.

WinZip utility: It is used to compress files.

Diagnostic utility: It is used to detect hardware and software problems.

Antivirus software: It is used to detect and remove viruses.

iv. Language Processors:

A language processor is a system program used to translate computer programs into machine language.

Machine language is directly understood by the computer. Therefore, all the programs must be translated into machine language before execution by the computer.

Compiler and interpreter:

Compiler and interpreter are language processors used to translate high level language programs into machine language.

Assembler:

A program called assembler is used to translate assembly language programs into machine language.

Q.60 What is application software? List the main groups of computer software?

Ans. Application Software:

Application software is developed for computer users to solve their problems such as preparing a letter, creating a presentation or managing a database.

Main groups of application software:

Commonly used application software includes productivity software, business software, entertainment software and education software.

Q.61 Elaborate open source software, shareware and freeware.

Ans. i. Open Source Software:

It is computer software that is available in the form of source code that allows users to study, change and improve it. Open source software is free for use, modification and distribution.

Examples of open source software:

Some examples of open source software are Linux operating system, Open Office (office productivity software), Flight Gear (flight simulator) and Java programming language, etc.

ii. Shareware:

Shareware is distributed free of cost for a limited period, usually one or two months. It is trial version of software given to people to decide whether they would like to buy the full version of the software.

Some shareware is installed on new computers when they are sold.

Examples of shareware:

Examples of shareware are antivirus software and computer games, etc.

ii. Freeware:

Freeware is given free of cost and it is full version of software for an unlimited period of time. It may have some restrictions such as allowed for personal or academic use only.

Examples of freeware:

Examples of freeware are Google Chrome, Mozilla Firefox, VLC media player, etc.

KEY POINTS

- Computer is a general-purpose programmable machine that has the ability to store, retrieve and process data that is represented in the form of 0s and 1s.
- First generation computers used vacuum tubes and their period was from 1940 to 1956.
- Second generation computers used transistors and their period was from 1956 to 1963.
- Third generation computers used IC chips that were developed in early 1960s and their period is from 1963 to 1971.
- Fourth generation computers use LSI and VLSI chips and their period is from 1971 to present.
- Fifth generation of computers is concerned with development of devices that can understand natural languages and have thinking power.
- Analog computer represents and processes data by measuring quantities such as voltage and current to solve a problem. It works on supply of continuous signals as input and displays output simultaneously.
- Digital computer works with binary digits 0 and 1. Data and instructions are fed into digital computer through an input device such as keyboard. The computer performs calculations on data according to the instructions and displays results on monitor or prints on printer.
- Hybrid computer is a combination of analog and digital computers. It combines the characteristics of both analog and digital computers.
- Mainframe computer is a very large, very powerful and expensive computer that can support hundreds and even thousands of users at the same time.
- Minicomputer is bigger than microcomputer but smaller than mainframe. It is used in organizations that have hundreds of users.
- Microcomputer is the smallest and the low cost computer. It is the most commonly used computer in homes and offices.
- Software engineer is a highly skilled person in the field of IT whose responsibilities involve the analysis, design, implementation and maintenance of computer software.
- Computer programmer is an IT professional who has extensive knowledge and expertise in programming languages. He programs the computer by writing step-by-step instructions that tell the computer what to do.
- System analyst analyzes the data processing requirements of organizations and develops information systems to implement them.
- Hardware engineer is an IT professional who designs and manufactures computer hardware.
- Network engineer is a person who is responsible for installation, configuration and maintenance of computer networks in organizations.
- Database administrator is a person who is responsible for the design, implementation and maintenance of a database in an organization.
- Web designer is a person whose job is to plan and create websites.

- Multimedia designer is a person who designs multimedia software by combining text, graphics, animation, audio and video.
- Information security analyst is a person whose job is to protect information and information systems from unauthorized access, use, modification, recording and destruction.
- Computer teacher is a person who teaches the subject of computer science to students.
- Computer hardware refers to the physical components that make up a computer system.
- Computer software is a set of instructions that tells a computer what to do and how to do.
- System software is a collection of programs which makes the use of computer easy and efficient.
- Operating system is system software that is responsible for the management and coordination of all the activities performed by the computer.
- Application software is developed to solve the problems of computer users such as writing letter, creating presentation or managing a database.
- Open source software is a program that is freely available in the form of source code that allows users to study, change and improve it.
- Shareware is trial version of software that is distributed free of cost for a limited period, usually one or two months.
- Freeware is software given free of cost for an unlimited period of time.

EXERCISE

Q1. Select the best answer for the following MCQs.

i. Who invented logarithm?

- | | |
|--------------------|---------------------|
| A. Blaise Pascal | B. John Napeir |
| C. Charles Babbage | D. Herman Hollerith |

ii. Which generation of computer used transistor?

- | | |
|--|--|
| A. 1 st Generation of Computers | B. 2 nd Generation of Computers |
| C. 3 rd Generation of Computers | D. 4 th Generation of Computers |

iii. In which generation of computer microprocessor was introduced?

- | | |
|--|--|
| A. 1 st Generation of Computers | B. 2 nd Generation of Computers |
| C. 3 rd Generation of Computers | D. 4 th Generation of Computers |

iv. Which of the following computer supports thousands of users at the same time?

- | | |
|-----------------------|--------------------|
| A. Microcomputer | B. Minicomputer |
| C. Mainframe computer | C. Laptop computer |

v. Who is responsible for protecting information and information systems from unauthorized people in an organization?

- | | |
|--------------------------|---------------------------------|
| A. System Analyst | B. Information Security Analyst |
| C. Network Administrator | D. Hardware Engineer |

vi. Which of the following is the fastest memory?

- | | |
|--------------------|--------|
| A. USB flash drive | B. RAM |
|--------------------|--------|

- Multimedia designer is a person who designs multimedia software by combining text, graphics, animation, audio and video.
- Information security analyst is a person whose job is to protect information and information systems from unauthorized access, use, modification, recording and destruction.
- Computer teacher is a person who teaches the subject of computer science to students.
- Computer hardware refers to the physical components that make up a computer system.
- Computer software is a set of instructions that tells a computer what to do and how to do.
- System software is a collection of programs which makes the use of computer easy and efficient.
- Operating system is system software that is responsible for the management and coordination of all the activities performed by the computer.
- Application software is developed to solve the problems of computer users such as writing letter, creating presentation or managing a database.
- Open source software is a program that is freely available in the form of source code that allows users to study, change and improve it.
- Shareware is trial version of software that is distributed free of cost for a limited period, usually one or two months.
- Freeware is software given free of cost for an unlimited period of time.

EXERCISE

Q1. Select the best answer for the following MCQs.

i. Who invented logarithm?

- | | |
|--------------------|---------------------|
| A. Blaise Pascal | B. John Napeir |
| C. Charles Babbage | D. Herman Hollerith |

ii. Which generation of computer used transistor?

- | | |
|--|--|
| A. 1 st Generation of Computers | B. 2 nd Generation of Computers |
| C. 3 rd Generation of Computers | D. 4 th Generation of Computers |

iii. In which generation of computer microprocessor was introduced?

- | | |
|--|--|
| A. 1 st Generation of Computers | B. 2 nd Generation of Computers |
| C. 3 rd Generation of Computers | D. 4 th Generation of Computers |

iv. Which of the following computer supports thousands of users at the same time?

- | | |
|-----------------------|--------------------|
| A. Microcomputer | B. Minicomputer |
| C. Mainframe computer | D. Laptop computer |

v. Who is responsible for protecting information and information systems from unauthorized people in an organization?

- | | |
|--------------------------|---------------------------------|
| A. System Analyst | B. Information Security Analyst |
| C. Network Administrator | D. Hardware Engineer |

vi. Which of the following is the fastest memory?

- | | |
|--------------------|--------|
| A. USB flash drive | B. RAM |
|--------------------|--------|

- B. ROM D. Cache
- vii. **What type of software a device driver is?**
 A. Application software B. Business software
 C. System software D. Productivity software
- viii. **Which of the following is volatile memory?**
 A. RAM B. ROM
 C. USB flash drive D. Hard disk
- ix. **Which software is distributed free of cost for a limited period as a trial version?**
 A. Open source software B. Shareware
 C. Freeware D. Productivity software
- x. **When were IC chips developed?**
 A. Early 1960s B. Early 1970s
 C. 1980s D. 1990s

Answers

i. B	ii. B	iii. D	iv. C	v. B
vi. D	vii. C	viii. A	ix. B	x. A

Q2. Write short answers of the following questions.

i. **Describe Napier's Bone and Slide Rule.**

Ans: Napier's Bone:

John Napier, a Scottish mathematician invented a calculating device called Napier's Bone in 1614.

Construction:

It consisted of a wooden box containing rotating cylinders each of which had the digits from 0 to 9.

Function:

It could multiply, divide and find square roots of numbers by using simple addition and subtraction. His biggest achievement was the invention of logarithm.

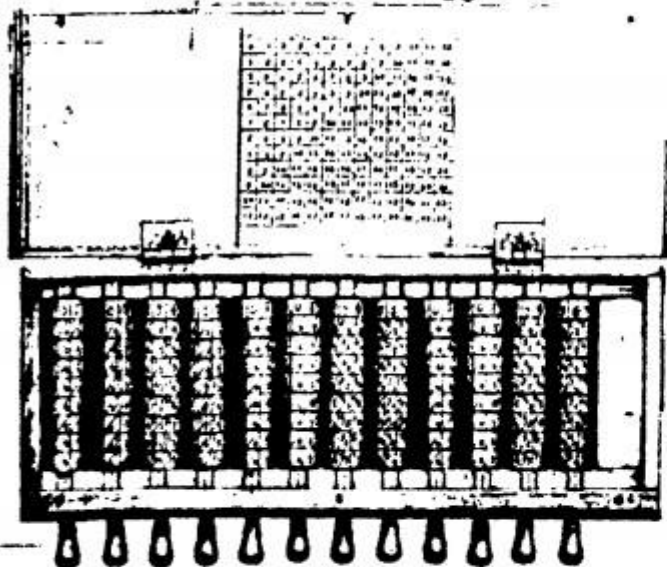

Napier's Bone

Napier's Bones

Cut along the vertical lines to make a strip for each number.

X	1	2	3	4	5	6	7	8	9
1	0	0	0	0	0	0	0	0	0
2	0	0	0	0	0	0	0	0	0
3	0	0	0	0	0	0	0	0	0
4	0	0	0	0	0	0	0	0	0
5	0	0	0	0	0	0	0	0	0
6	0	0	0	0	0	0	0	0	0
7	0	0	0	0	0	0	0	0	0
8	0	0	0	0	0	0	0	0	0
9	0	0	0	0	0	0	0	0	0

Slide Rule:

Based on the idea of logarithm, English mathematician, William Oughtred developed a device called Slide Rule in 1620s.

Function:

it was very useful for solving problems that involved multiplications and divisions.

Construction:

it has three parts, slide, rule and a transparent sliding cursor as shown in Fig.

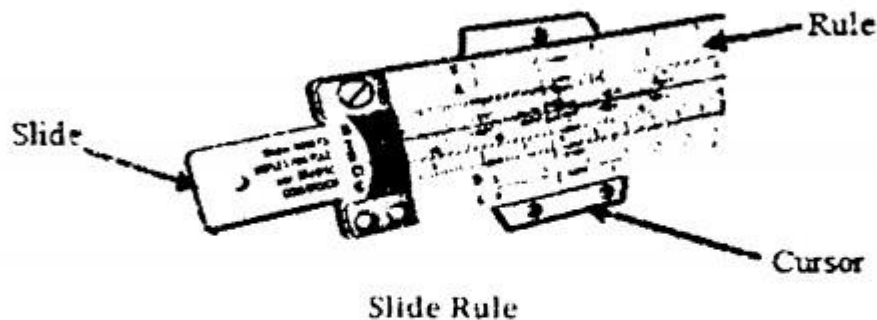

Do You Know?

Slide rule was replaced by electronic pocket calculator in the early 1970s.

ii. **Compare 1st and 3rd generation computers.**

Ans: First Generation Computers (1940 – 1956):

Technology used:

Vacuum tubes were used in the first generation computers.

Problems arising from the use of computers Vacuum tubes:

Vacuum tubes generated so much heat that they had to be cooled by air conditioner. Vacuum tubes burnt out very often and it was difficult to repair and maintain the computers of first generation.

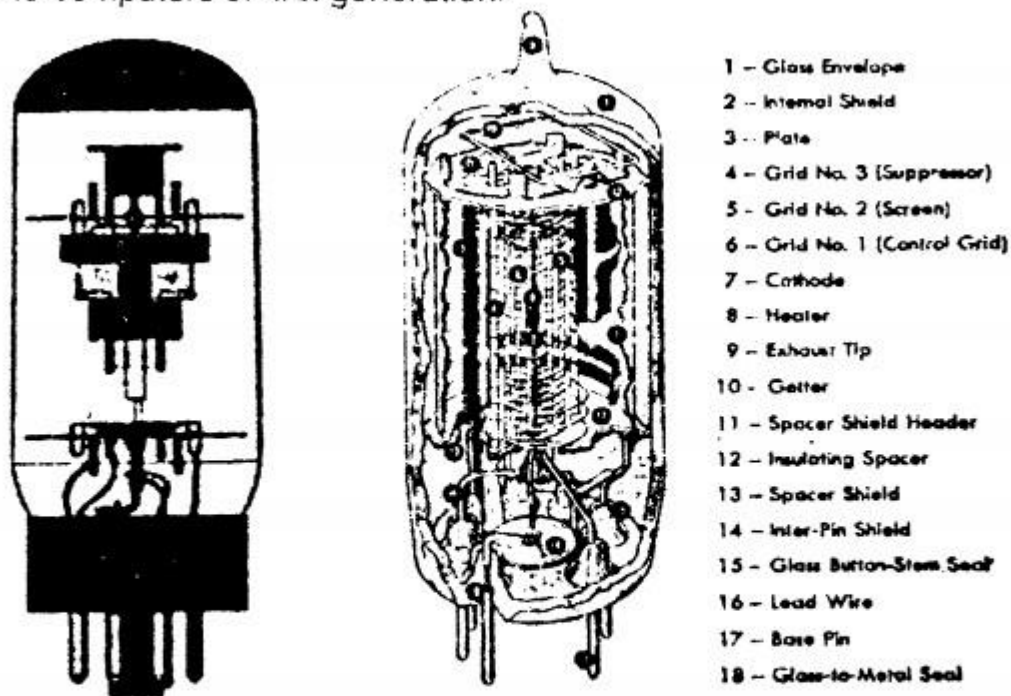

Vacuum Tube

Features/ characteristics of first generation computers:

The following are the characteristics of first generation computers.

- First generation computers used vacuum tubes.
- Speed was slow and memory was very small.

- They were huge in size taking up entire room.
- First generation computers were very expensive and unreliable.
- They consumed a lot of power and generated a lot of heat.
- Input was based on punched cards.
- Output was obtained on printouts through electric typewriter.
- Machine language was used in these computers.

Examples of first generation computers:

Some examples of first generation Mini/Mainframe computers are ENIAC, UNIVAC I, IBM 604, Mark-I and EDSAC.

Third Generation Computers (1963 – 1971):

Technology used:

Integrated Circuits (ICs), also known as semiconductor chips were used in third generation of computers instead of transistors. IC chips were developed in early 1960s.

IC chip:

A single IC chip contains a large number of transistors. IC chips increased the power and decreased the cost of computers. Invention of IC chips was a great breakthrough in advancing computer technology. IC chips are shown in Fig.

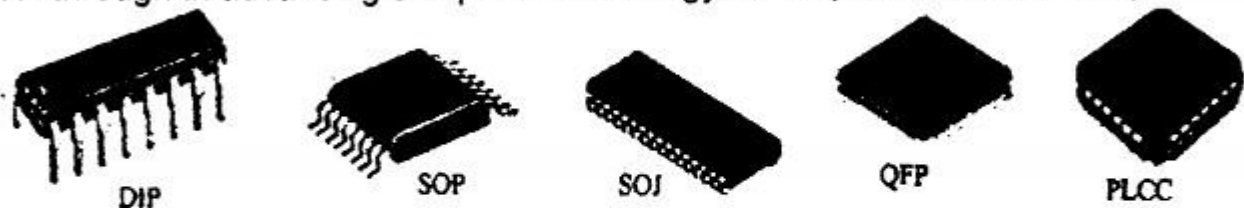

IC Chips

Features/ characteristics of third generation computers:

- The following are the characteristics of third generation of computers.
- Third generation computers used IC chips.
- IC chips improved the speed and memory of computers.
- Computers consumed less electricity, became smaller, cheaper and more reliable than second generation computers.
- Keyboard and monitor were used with the computer.
- These computers could run different application programs at the same time.

Examples of third generation computers:

Some examples of third generation computers are Burroughs 6700, IBM System/360, System 3 and Control Data Corporation's 3300 and 6600 computers.

iii. Differentiate between analog and digital computers.

Ans: Analog Computers:

Analog computers represent and process data by measuring quantities such as voltage and current to solve a problem.

They work on supply of continuous signals as input and display output simultaneously. Analog computers are special purpose devices, designed to perform single specific task.

Mostly these devices are used in engineering and scientific applications.

Features/ characteristics of Analog Computers:

The accuracy of analog computers is low but they are faster in speed as compared to digital computers.

Construction:

They mainly consist of electrical devices such as resistors, capacitors, transistors, etc. An analog computer with volt meter is shown in Fig.

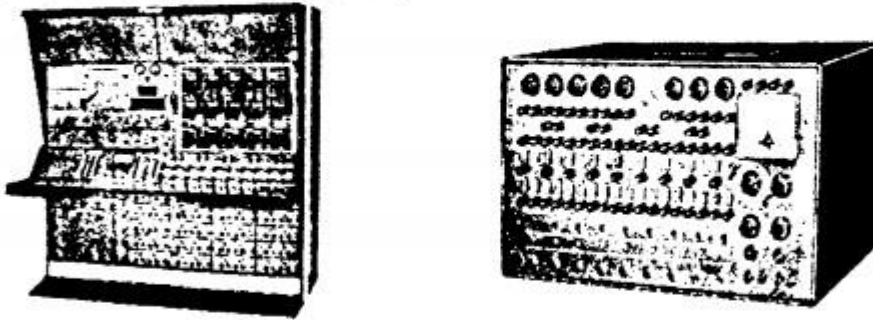

Analog Computer

Digital Computer:

Digital computer works with digits. Everything in a digital computer is represented with binary digits 0s and 1s. It manipulates them at very fast speed. Data and instructions are fed into the digital computer through an input device in the form of 0s and 1s.

Features/ characteristics of Digital Computer:

The computer performs calculations on data according to the instructions given in a computer program. The results of calculations are displayed on monitor or printed on printer. A digital computer is shown in Fig.

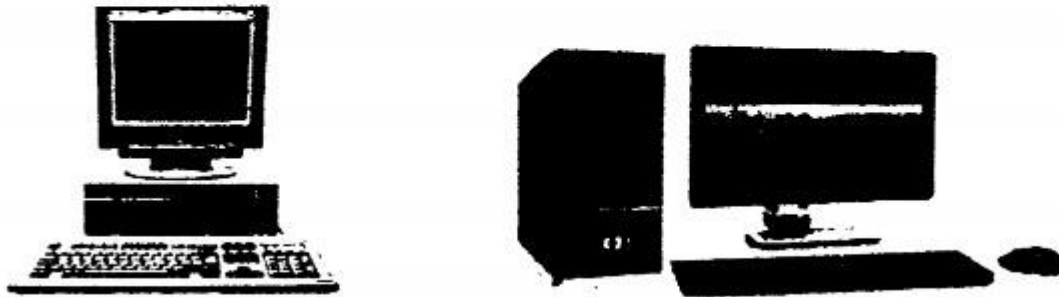

Digital Computer

Digital computers can store and process large amount of information at high speed. The results produced by digital computers are reliable and accurate. Digital computers are general-purpose computers, used in various fields.

OR (Second Answer)

Ans. Difference between an analog and a digital computer:

Analog computer	Digital computer
i- An analog computer accepts data in continuous or physical form, represents it in a suitable form to perform scientific operations.	i- A digital computer accepts data in the form of digits represents it in terms of discrete numbers and processes numbers using various Arithmetic and logic operations.
ii- These are special purpose computers	ii- These are general purpose computers.
iii-These computers have no operational state.	iii-These computers have only two states On (0) and off (1).
iv- Fast in processing as compare to digital computers.	iv- Low processing speed as compare to analog computers.

v- Accuracy is less as compare to digital computers.	v- These computers are more accurate as compare to digital computers.
vi- These computers have small memory size.	vi- The memory capacity is huge.
vii- These computers are used in complex scientific and mathematical calculations.	vii- These computers are used in scientific and technical research, business, education, healthcare, supermarkets, factories, banking, transportation, space exploration, art and music etc.
Examples: Heath Kit EC-1 an educational analog computer by USA in 1960.	Examples: IBM PCs. Apple Macintosh computers.

iv. Ahmed, a class IX student is asking his father to replace his home computer CRT monitor with LCD monitor. How will you justify his demand?

Ans: Justification of his demand:

LCDs are free from geometric image distortions at the screen edges because they are a flat matrix display where every pixel is active.

LCDs have uniform screen brightness and the screen is covered with a flexible surface that is substantially less prone to specular glare compared to a glass covered CRT monitor screen.

LCDs are flicker free, which should reduce the risks of headaches and eyestrain.

Because LCDs are smaller than CRT monitor, LCDs required little space than CRT monitor.

LCD also require lesser energy than CRT Monitors.

v. What will happen if storage devices are removed from a computer?

Ans: Storage devices are core function and fundamental component of computers. The Purpose of the memory device is to store the information and for the information retrieval. If storage devices are removed from a computer then it will not possible to store the information and information retrieval.

vi. Differentiate between systems software and application software.

Ans: System Software:

System software is a collection of programs which makes the use of computer easy and efficient. Highly experienced computer programmers develop system software.

Following are the types of system software.

i. Operating system

ii. Device drivers

iii. Utility programs

iv. Language processors

Application Software:

Application software is developed for computer users to solve their problems such as preparing a letter, creating a presentation or managing a database.

Commonly used application software includes productivity software, business software, entertainment software and education software.

vii. How a student can use computer to improve academic performance?

Ans:

- Using computer applications increases the students' motivation for learning Management.
- Using of computer catch the attention of the students and increase their interest for learning Management.
- Using computer applications lead to the development of students' skills.
- Using computer applications develops the students' process of thinking critically.
- Using computer applications creates the opportunity for students to be active in class, and not passive.
- Using computer applications creates the opportunity for students to solve different case studies, to change the variables in these case studies and to see the results of these changes.
- Using computer applications prepares the students for the knowledge-based society and economy which cannot be understood nowadays without computers in our day-to-day life.
- Using computer applications contributes to the students' engagement in the process of learning Management.

viii. Give any three uses of computers in a school library.

Ans: Uses of computers in a school library:

- Access to large amounts of information to users wherever they are and whenever they need it.
- Access to primary information sources.
- Network accessibility on Intranet and Internet.
- User-friendly interface.
- Advanced search and retrieval.
- Multiple access/ Universal accessibility.
- Integration with other digital libraries.

ix. Name few house hold appliances in which microprocessor is used.

Ans: Today, microprocessor is not only used in microcomputers, they are also used in the devices including mobile phones, microwave ovens, cameras, washing machines, televisions, etc.

x. What are the tasks performed by operating system?

Ans: The following tasks are performed by the operating system.

- i. It loads programs into memory and executes them.
- ii. It controls the operation of input/output and storage devices.
- iii. It manages files and folders.
- iv. It allows to create password to protect computers from unauthorized use.
- v. It detects hardware failures and displays messages to fix them.

Q3. Write long answers of the following questions.

i. Describe the five generations of computers.

Ans: See Q#10 Page 9, Q#11 Page 9, Q#12 Page 11, Q#2 (ii) 32.

ii. Write a note on mainframe, minicomputer and microcomputer.

Ans: Mainframe Computer:

Mainframe computers were developed in early 1940s.

A mainframe computer is a very large, very powerful and expensive computer that can support hundreds and even thousands of users at the same time. Therefore, these computers are used in large organizations.

The modern mainframe computers that use cutting edge technology are the foundation of today's business in banking, insurance, education, air travel, research, health care, government and many other public and private organization. These computers can execute more than trillion instructions per second (TIPS). Some examples of mainframe computers are IBM's zEnterprise EC12, EC 196, HP 16500 Series and HP Integrity Superdome. A mainframe is shown in Fig.



Mainframe computer

Minicomputer:

Minicomputer was introduced in the 1960s when IC chips were introduced. A minicomputer is bigger than a microcomputer but smaller than a mainframe. These computers can execute billions of instructions per second (BIPS). Therefore, they can process more data than microcomputers. Today, minicomputers with cutting edge technology are playing an important role in business organizations for their data processing requirements. These are used in organizations that have hundreds of users such as PIA, NADRA, police departments, hospitals, etc. A minicomputer is shown in Fig. Examples of minicomputers are IBM System/36 and HP 3000.

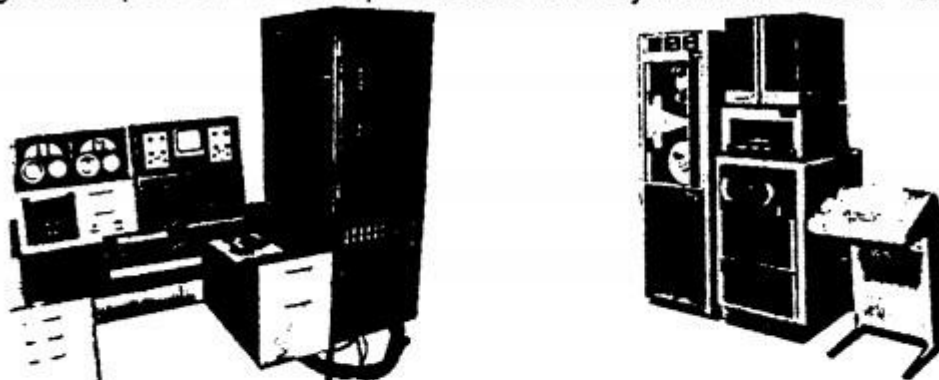

Minicomputer

Microcomputer:

Microcomputers are the smallest and the low cost computers. These computers are most commonly used in homes and offices. Microcomputer was introduced in 1970s when microprocessor was developed. A microprocessor is a single chip that controls the operations of the entire computer system. Modern microcomputers have large storage capacity and they can execute millions of

instructions per second (MIPS). A variety of software is available for use in these computers.

Microcomputers are available in various forms such as desktop, laptop and tablet as shown in Fig.



Microcomputer: (a) Desktop

(b) Laptop

(c) Tablet Microcomputer

Some popular companies that manufacture microcomputers are IBM, Dell, HP, Toshiba and Acer. A microcomputer is also known as Personal Computer or PC. IBM Lenovo series, Dell XPS series and HP Envy series are some popular microcomputers.

iii. Explain the basic operations of a computer.

Ans: **Basic Operations of a Computer:**

The following four basic operations are performed by computers which are shown in Fig.

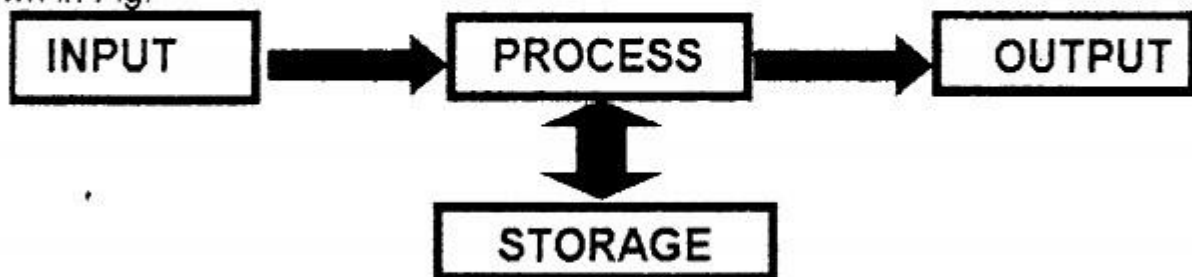

Basic operations of a computer

- Input operation
- Storage operation
- Processing operation
- Output operation

Input Operation:

A computer is a data processing machine. Users enter data and instructions into the computer through keyboard or mouse. It can also be provided to the computer from a storage device such as hard disk, CD or USB memory. The input data/instructions are stored in memory for further processing.

Processing Operation:

Microprocessor processes the data according to the instruction given to it. The microprocessor fetches the data/instructions from the memory and stores it in instruction register. The control unit then decodes the instruction to find out which operation is to be performed. After decoding the instruction, it sends signals to other parts of the computer to execute it.

Storage Operation:

The results produced after processing are stored in memory before they are sent to the output device or permanent storage device like hard disk.

Output Operation:

The results of data processing stored in memory must be output so that they can be seen by the user. The control unit displays the results on the monitor or

prints it on the printer. Results can also be saved in a storage device such as hard disk for use in the future.

iv. **Write short note on the following.**

- a. **Hardware Engineer**
- b. **Network Administrator**
- c. **Database Administrator**
- d. **Web Designer**
- e. **Multimedia Designer**

Ans: a. Hardware Engineer:

Hardware engineers design and manufacture computer hardware. Their work also involves repair and maintenance of computer hardware. They have in-depth knowledge of internal working of computers, processors, circuit boards and other electronic equipment.

b. Network Administrator:

Network administrators are responsible for installation, configuration and maintenance of computer networks in organizations. They are in charge of maintenance of computer hardware and software that make up a computer network. They assign passwords to network users so that unauthorized people do not have access to network.

c. Database Administrator:

Database administrator is a person who is responsible for the design, implementation and maintenance of a database in an organization. He is also responsible for maintaining security and monitoring the performance of database.

d. Web Designer:

Web designer is a person whose job is to plan and create websites. He designs web pages that include text, images, sound, video clips and make the website interactive. HTML (Hypertext Markup Language) is the most commonly used language for creating websites.

e. Multimedia Designer:

Multimedia designers are people who organize and present information in an easy to understand and attractive manner. They combine text, graphics, animation, audio and video. Multimedia designers create digital images and arrange them in sequence for animation using computer software. They have the skills to edit and manipulate audio/video files. They usually work in film/TV industry, computer software companies and advertising companies.

v. **Describe the following types of application software.**

- a. **Productivity software**
- b. **Business software**
- c. **Entertainment software**
- d. **Education software**

OR

Identify the use of productivity, business, entertainment and education software.

Ans: a. Productivity software:

Productivity software includes word-processing, spreadsheet and database management software packages. These software packages are used by individuals to speed up their daily routine tasks by doing their work in an organized and efficient way.

b. Business software:

Any software that helps in running business in a more efficient way to improve productivity is known as business software. Some examples of commonly used business software are accounting, sales and marketing, inventory control, project management and payroll software.

c. Entertainment software:

Software developed to entertain people is known as entertainment software. Video games are one of the most popular forms of entertainment software. Many games are lot of fun to play but sometimes they can also help to improve skills such as typing or reading. The term edutainment merges games and education software into single software. Edutainment software is used mainly for entertainment but it educates as well.

d. Education software:

Software developed for educational purpose is known as education software. A large variety of education software has been developed. Education software includes typing tutor, spelling tutor, language learning, medical and healthcare, driving test and flight simulation software, etc.

Lab Activities

Activity 1:

Demonstrate how input/output devices are connected to the system unit of the computer.

Activity 2:

Students should be shown components of computer such as RAM, ROM, microprocessor, ports, expansion slots and power supply attached to the computer system.

CHAPTER 2

FUNDAMENTALS OF OPERATING SYSTEM

SHORT AND LONG QUESTIONS

Q.1 What is an operating system?

Ans: Operating System:

Operating system is a collection of system software that controls the working of computer system. It acts as an interface between the computer user and computer. It facilitates program execution and helps in developing application programs.

Q.2 List common types of operating systems?

Ans: Common Types of Operating Systems:

There are three types of operating systems based on ways of interaction with computer (interface). The three types of interfaces are:

- Command Line Interface.
- Menu Driven Interface.
- Graphical User Interface (GUI).

Q.3 What is Disk Operating System (DOS)?

Ans: Disk Operating System (DOS):

DOS was the most popular CLI operating system. DOS displays the prompt (C:\>) to enter commands. User must know the syntax of the command. DOS commands are difficult to remember. Some DOS commands are still supported by the new Windows operating system. It is a single user and single task operating system.

```
C:\DOSTEST>dir
Volume in drive C has no label.
Volume Serial Number is 7E8A-FA7D

Directory of C:\DOSTEST

02/09/2012  13:38    <DIR>          .
02/09/2012  13:38    <DIR>          ..
02/09/2012  13:38                7 file.txt
               1 File(s)                7 bytes
               2 Dir(s)  133,860,997,120 bytes free

C:\DOSTEST>copy *.txt */date:/*_*.txt
file.txt
               1 file(s) copied.

C:\DOSTEST>dir
Volume in drive C has no label.
Volume Serial Number is 7E8A-FA7D

Directory of C:\DOSTEST

02/09/2012  13:40    <DIR>          .
02/09/2012  13:40    <DIR>          ..
02/09/2012  13:38                7 file.txt
02/09/2012  13:38                7 file.txt_02092012_*.txt
               2 File(s)                14 bytes
               2 Dir(s)  133,850,974,208 bytes free

C:\DOSTEST>
```

DOS Interface

Examples of DOS commands:

The following are some examples of DOS commands with their description

DIR Display the contents of current directory (folder)

FORMAT D: Format the D drive

CD\PICS: CD stands for Change Directory, which makes Pics the current directory

Some DOS commands are shown in Fig.

Do You Know?

Microsoft introduced the MS DOS in 1981 and it was replaced by Windows 3.0 in 1990.

Q.4 List the classification of operating system.

Ans: Classification of Operating System:

Operating systems can be classified into two major categories, single-user and multi-user operating systems.

Q.5 List the types of operating system.

Ans: Types of Operating Systems:

There are three types of operating systems. These are batch processing, Time-sharing and real-time operating systems.

Q.6 A GUI operating system provides a user-friendly interface explain it.

Ans: Getting Started with GUI Operating System:

A GUI Operating System provides a user-friendly interface. This makes it easier for people with little computer skills to operate the computer. A GUI combines four elements which are Window, Icon, Menu and Pointer. All the information displayed on the screen is presented inside a window.

Small graphical symbols known as icons are used to represent files, folders, drives, programs and commands. Menus present various commands from which the user makes a selection with a pointing device. Mouse or touchpad is used as pointing device for performing different tasks such as selecting an option or opening a file, folder or program.

Tip

You can delete a file from your hard disk without sending it to **Recycle Bin** by clicking the file and then pressing **Shift + Delete**

Do You Know?

Right click a shortcut icon, select **Properties** and click **Open File Location** to know the location of program, file or folder to which a shortcut belongs.

Tip

You can create a new folder in Windows Explorer by simply pressing the **Ctrl+Shift+N** keys and then rename it.

Q.7 List the various steps to create a new folder.

Ans: Steps to create a new folder:

The following are the steps to create a new folder.

1. Go to the location where a folder is to be created.

- Right-click a blank area, point to New in the shortcut menu and then click **Folder** as shown in Fig.
- Type a name for the new folder and then press **Enter** key.

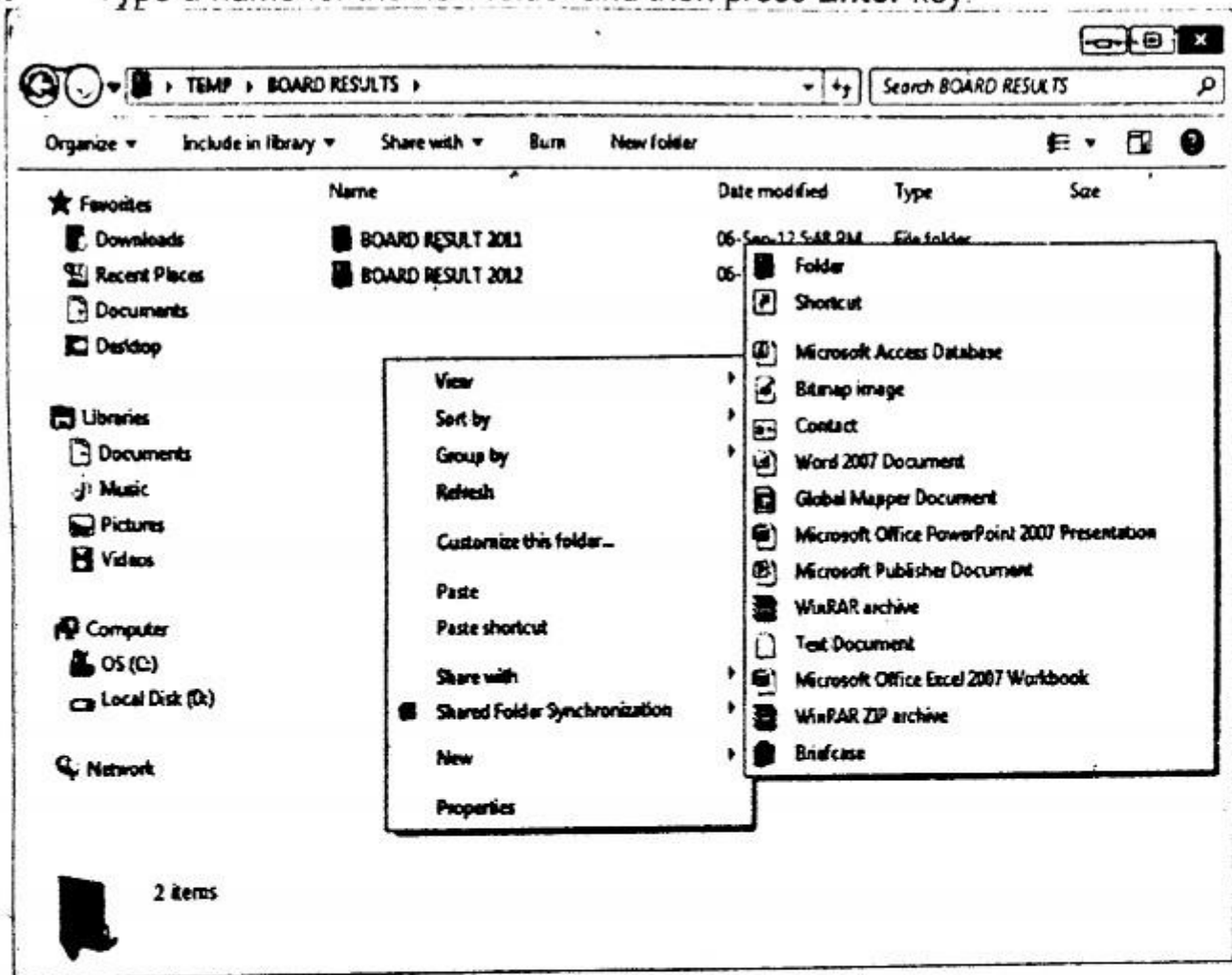

Shortcut menu to create a folder

Q.8 List the various steps to copy or move files.

Ans: Steps to copy or move files:

The following are the steps to copy or move files.

- Go to the location from where files are to be copied or moved.
- Select the files to copy or move.
To select consecutive group of multiple files or folders, create a selection around the outside of all the items by dragging the mouse pointer.
To select non-consecutive group of files or folders, press and hold down the **Ctrl** key and then click each item one by one.
To select all the items in a window, click **Organize** on the toolbar and then click **Select all**.
- Right-click on any selected file icon and then select copy or move from the shortcut menu as shown in Fig.
- Go to the location where the files are to be copied or moved.
- Right-click a blank area and click **Paste**.

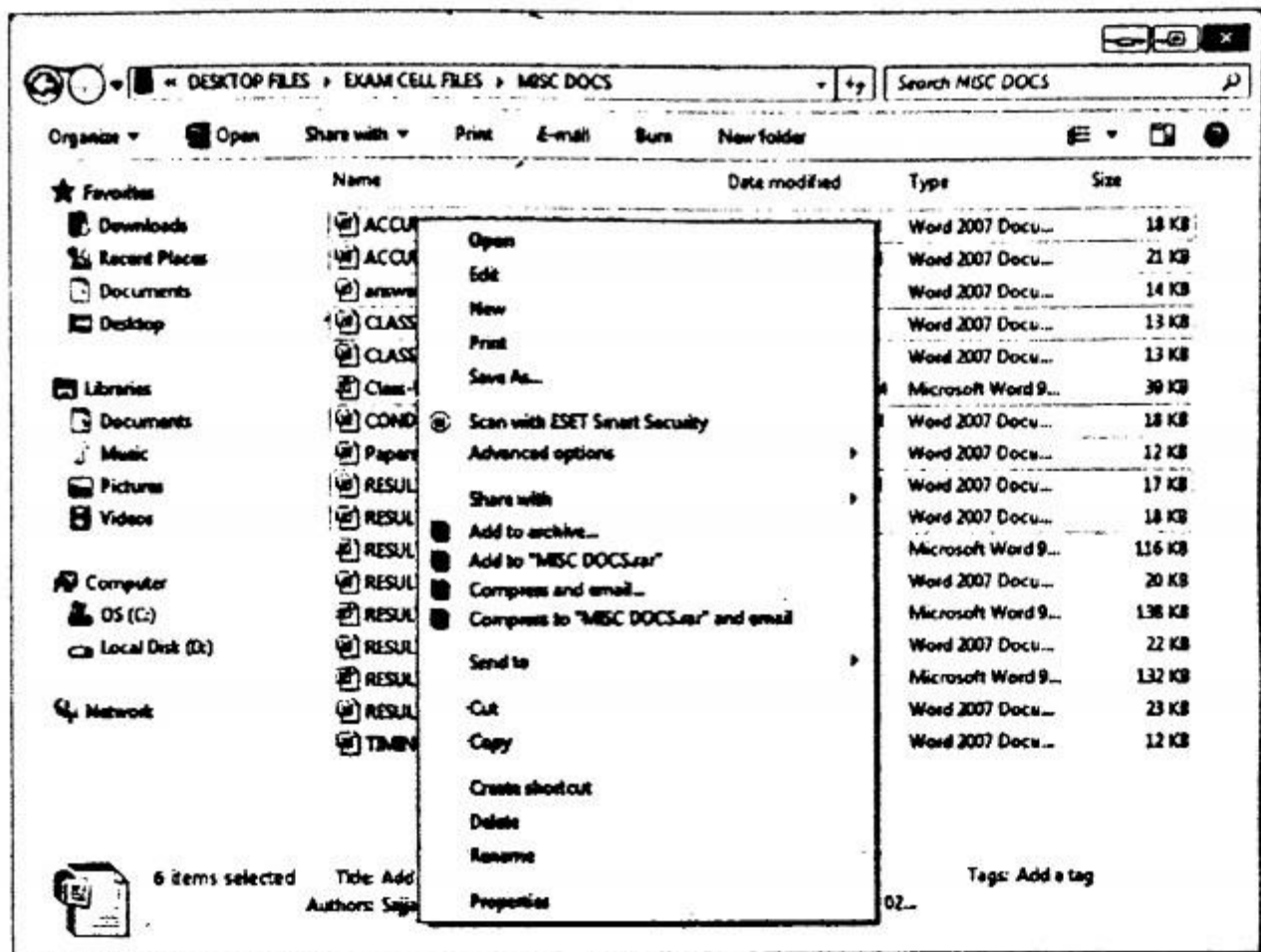

Shortcut menu for copying or moving files

Q.9 List the various steps to delete files or folders.

Ans: The following are the steps to delete files or folders.

1. Go to the location from where files or folders are to be deleted.
2. Select the items to delete as describe earlier.
3. Right-click any selected item and then click **Delete** in the shortcut menu.

Do you Know?

There are six different versions of Windows 7. These are Starter, Home Basic, Home Premium, Professional, Enterprise and Ultimate

Q.10 What is system installation?

Ans: System Installation:

A computer system consists of hardware and software. Before the use of computer, user must install the operating system and other required software.

Q.11 Briefly explain the process of installation of window 10-Operating System?

Ans: Installation of Windows 10 Operating System:

The following are the steps for installation of Windows 10 operating system.

1. Turn on the computer and insert the Windows 10 DVD and boot the computer. Make sure DVD is set as the first boot device.
2. When the screen shown in Fig. appears, select the Language, Time and currency format, Keyboard or input method and click **Next**.

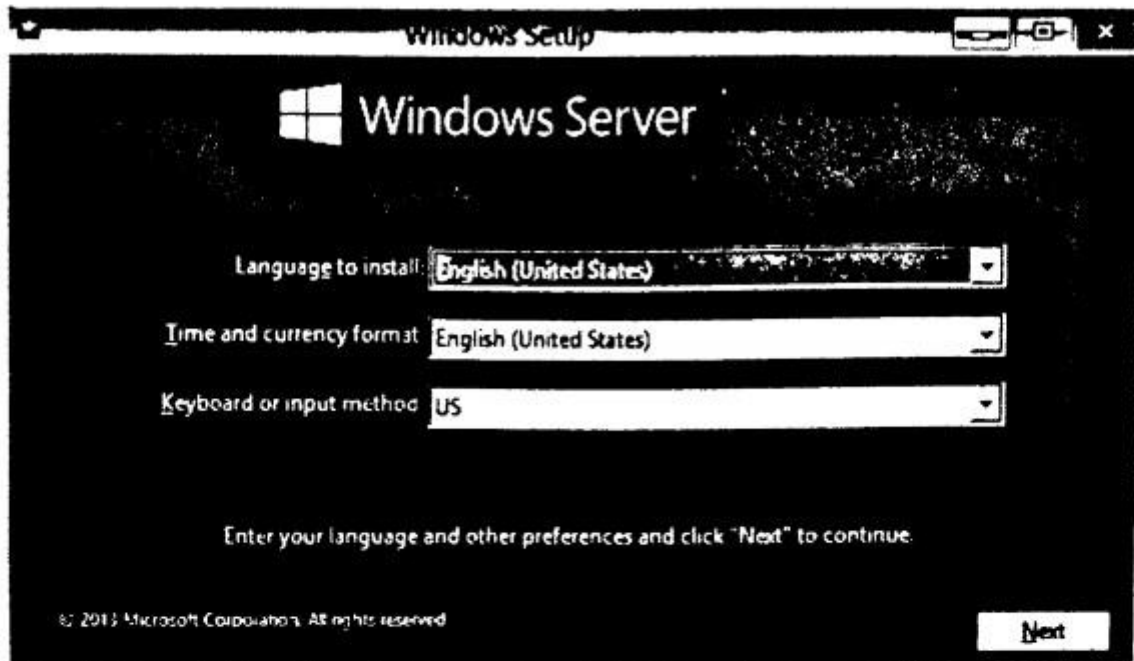

Screen to select language and time and currency format

3. Click Install now in the screen shown in Fig. to start installation of Windows 10.



Screen to Install now

4. Wait for a few seconds for the setup to start (Fig).



5. If you have a product key, enter it, otherwise click on Skip (Fig).

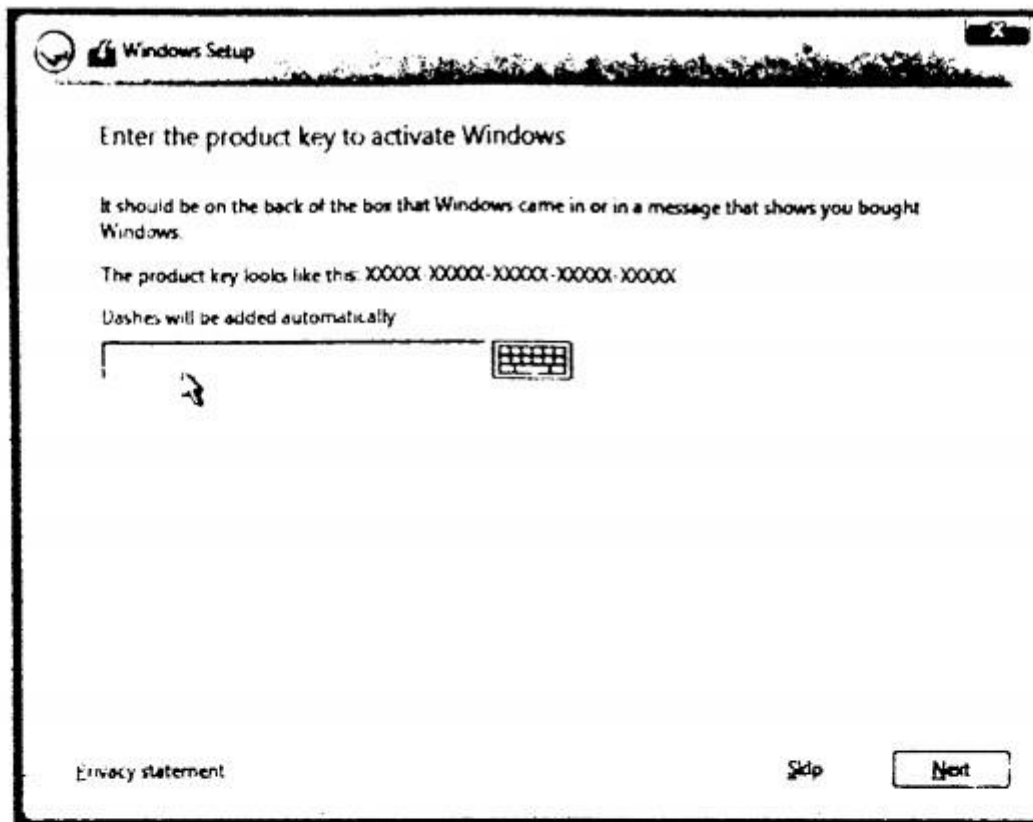

6. Accept the license terms and click on Next (Fig).

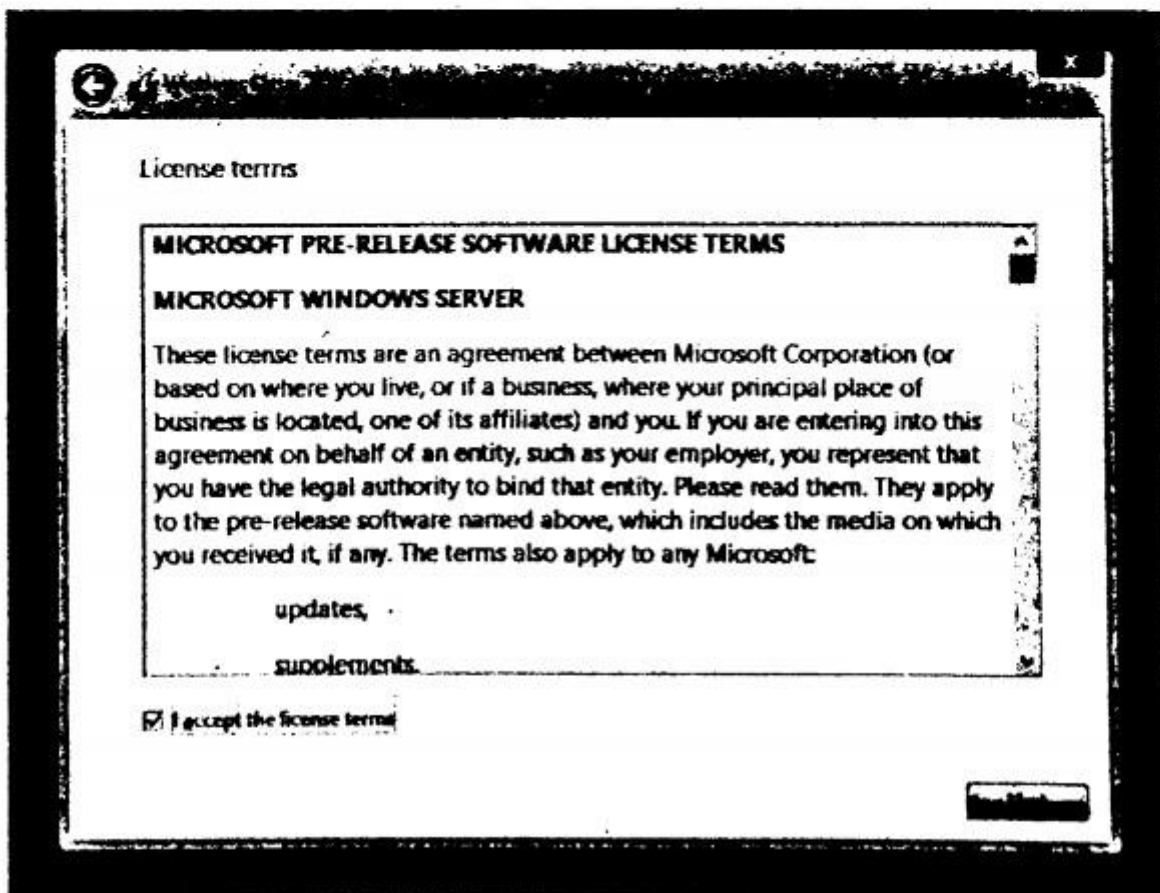

7. Select "Custom: install Windows only (Advanced)" (Fig).

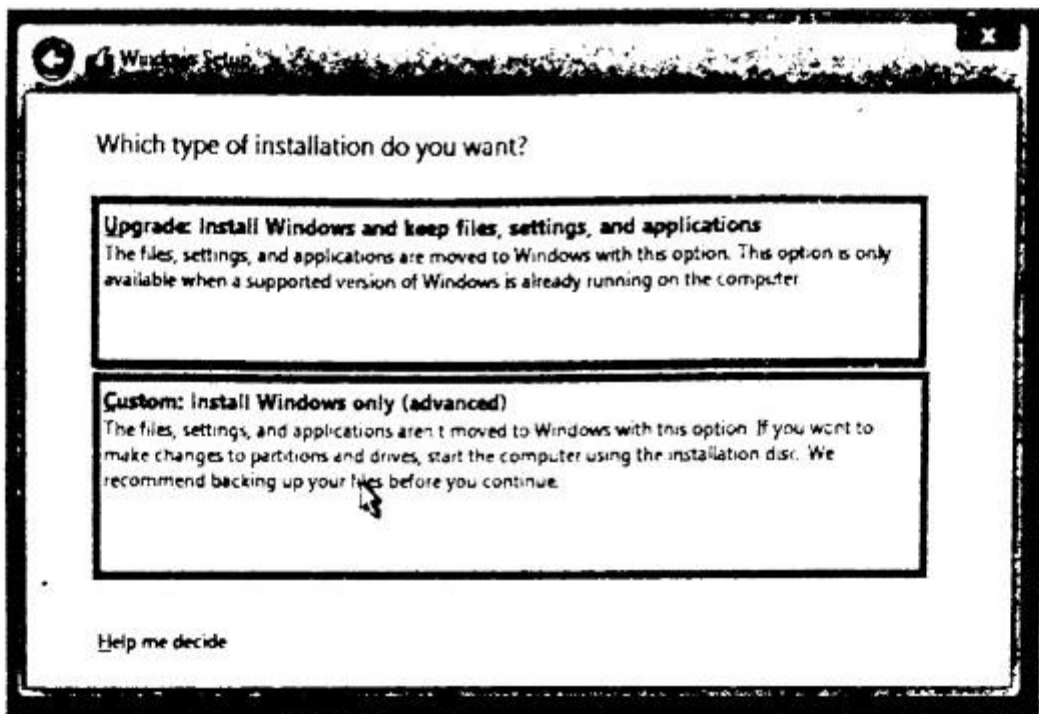

8. Select the drive where you want to install Windows 10 (Fig).

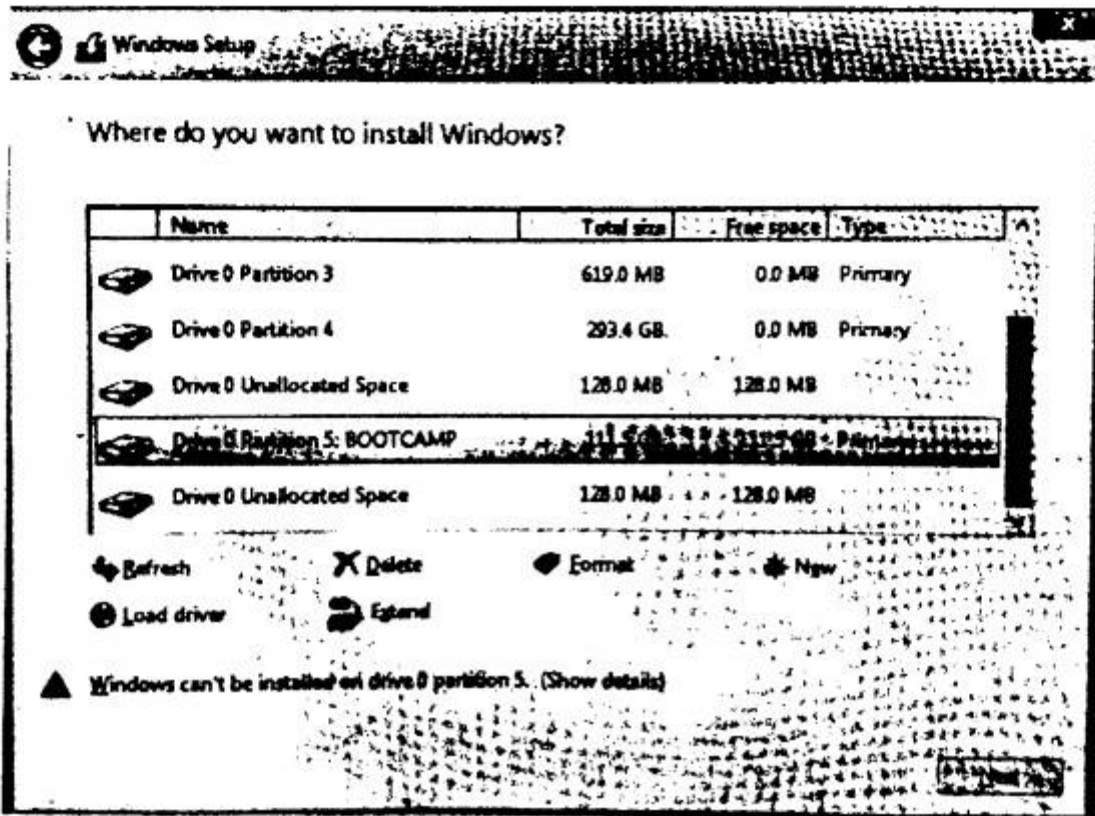

Note: Make sure the drive is formatted, if not you can format by selecting the format option provided.

9. Wait for a sometime until Windows is being installed. This may take from a few minutes to an hour depending on the hardware of your personal computer. Once this process is complete, your PC will restart (Fig).

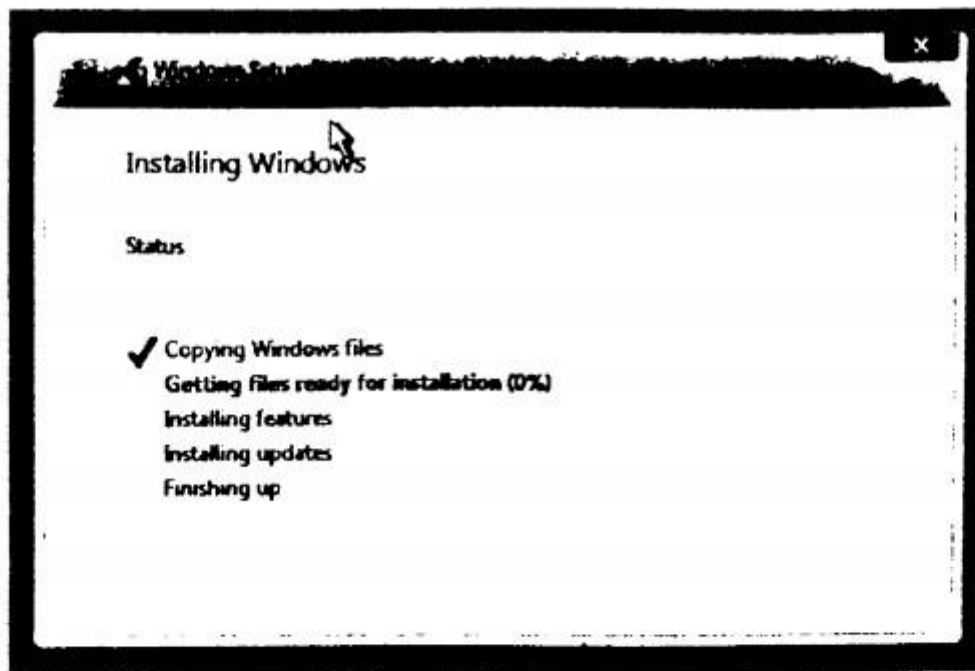

10. Choose Windows 10 (Fig).

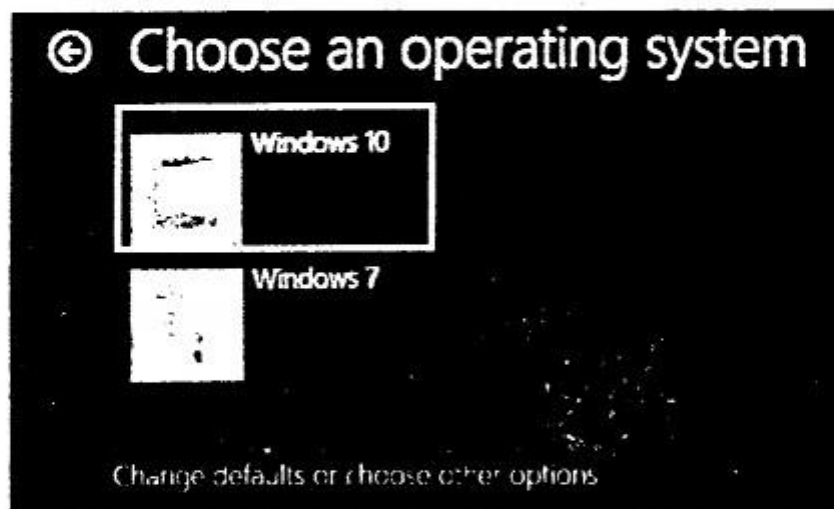

11. Wait for some more time (Fig).



12. Enter a serial key, otherwise click on Do this later to skip this option (Fig).

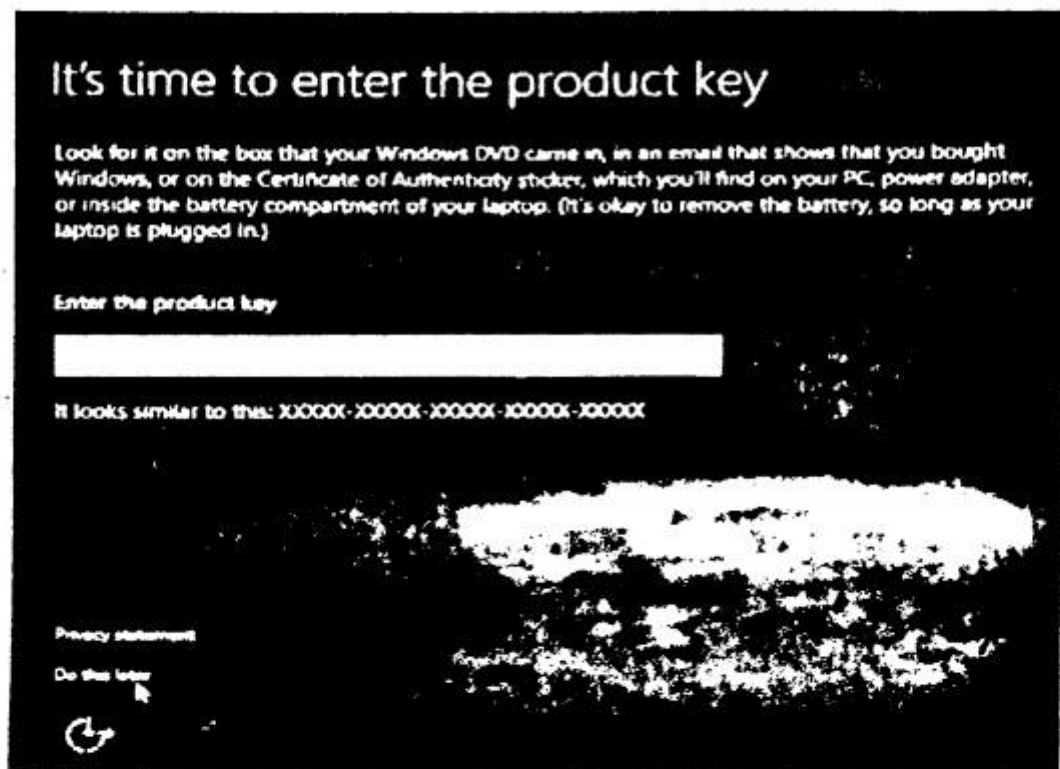

13. Click on Use express settings to use the recommended settings. Alternatively you can even click on Customize settings to customize the settings (Fig).

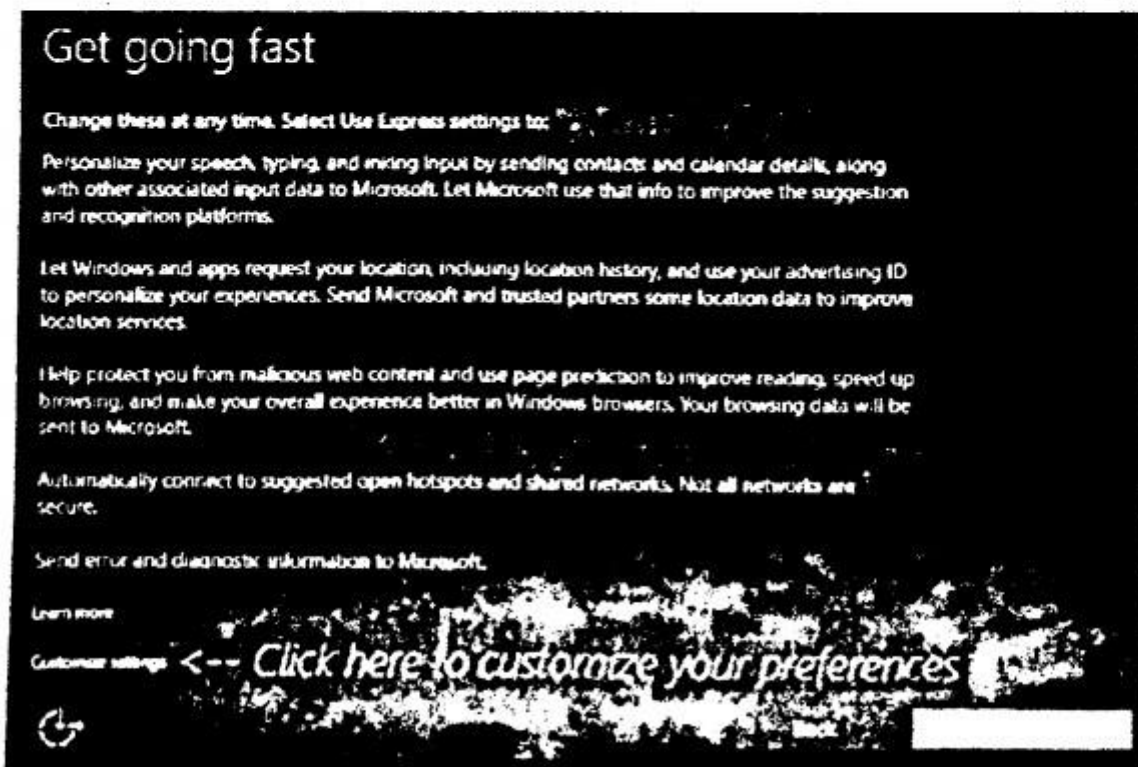

14. Wait for a few seconds more (Fig).



15. Enter a name and password to create your account (Fig).

Create an account for this PC

If you want to use a password, choose something that will be easy for you to remember but hard for others to guess.

Who's going to use this PC?

Make it secure.

16. Wait for a few seconds more (Fig).



(a)

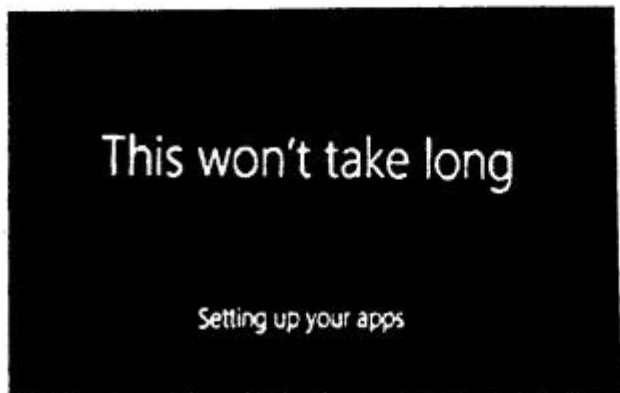

(b)

17. There you go, you are finally on Windows 10 (Fig).

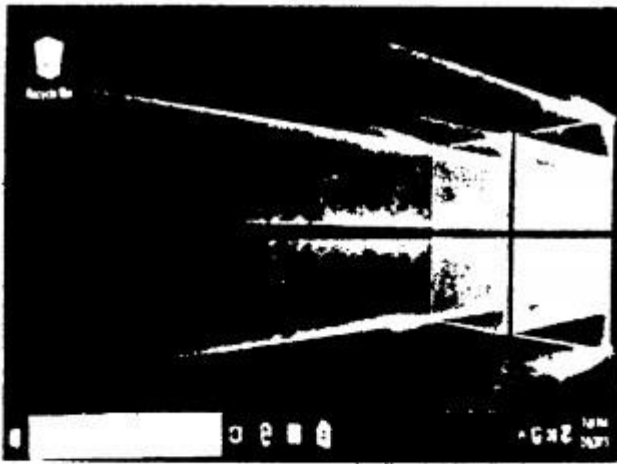

(a)

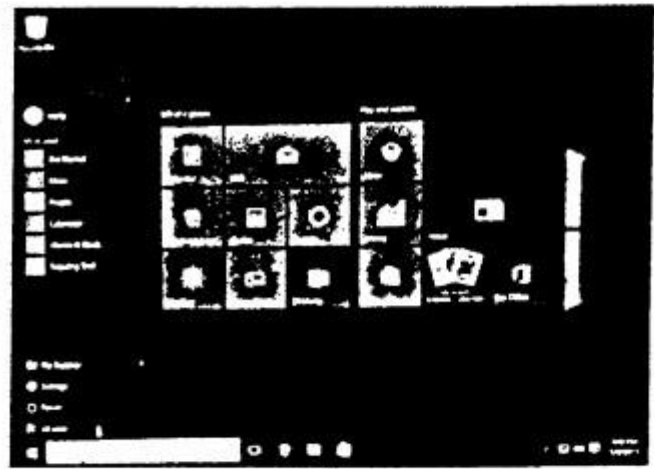

(b)

Q.12 Briefly explain the process of installation of antivirus software.

Ans: **Installation of Antivirus Software:**

The following are the steps for installation of AVG Antivirus software.

1. Download the AVG Antivirus Free Edition from Internet that runs on Microsoft Windows.
2. Double-click on the installation program shown in Fig.



AVG Anti-Virus

DOWNLOAD AVG ANTI-VIRUS 2012

Icon of AVG Antivirus program

3. Welcome screen will appear as shown in Fig. Click the Next button to proceed with the installation.

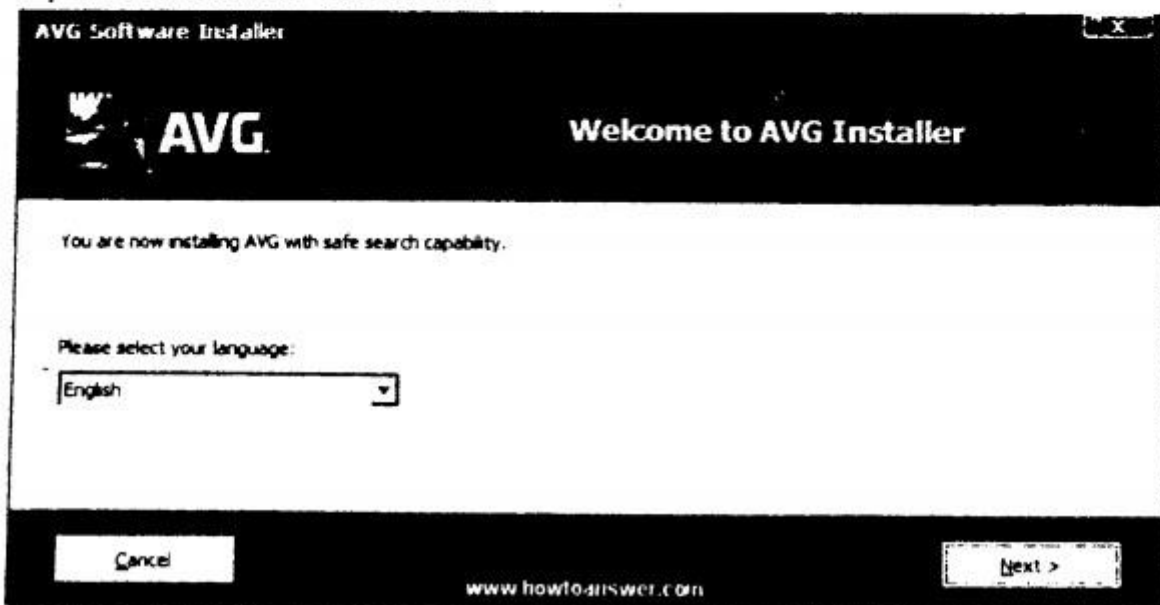

Welcome screen of AVG Antivirus

4. License Agreement screen will be displayed as shown in Fig. Click Accept to continue with the installation.

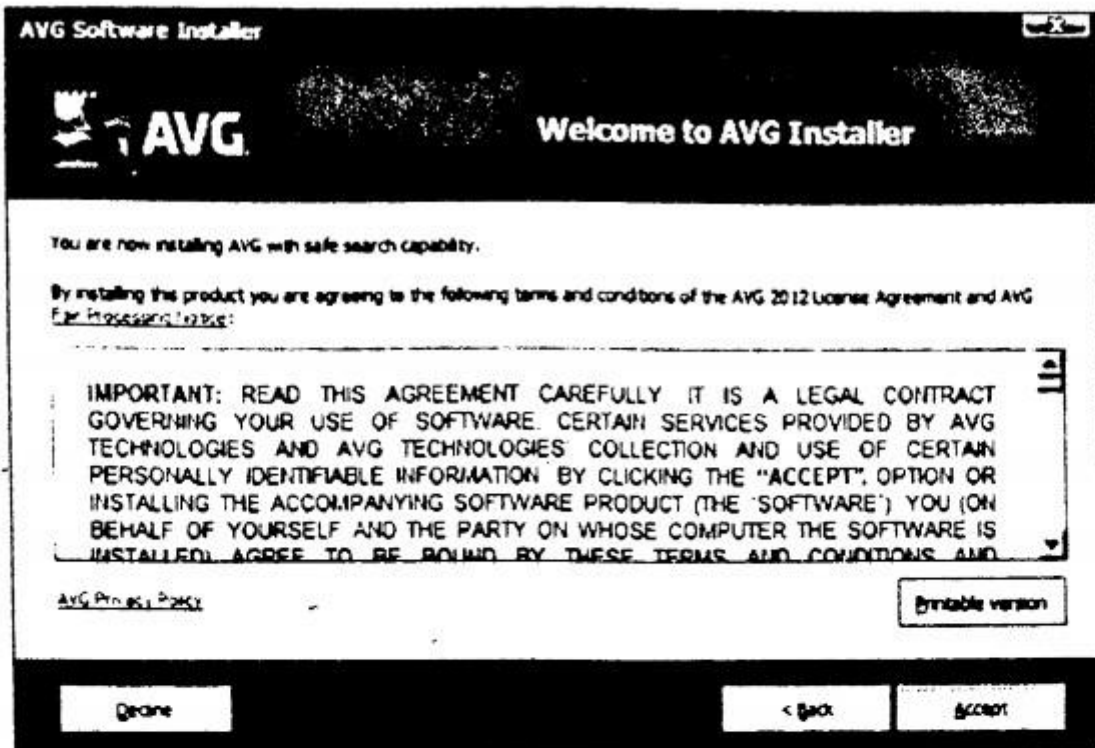

License Agreement screen

5. Select Express Install in the screen shown in Fig. and click Next.

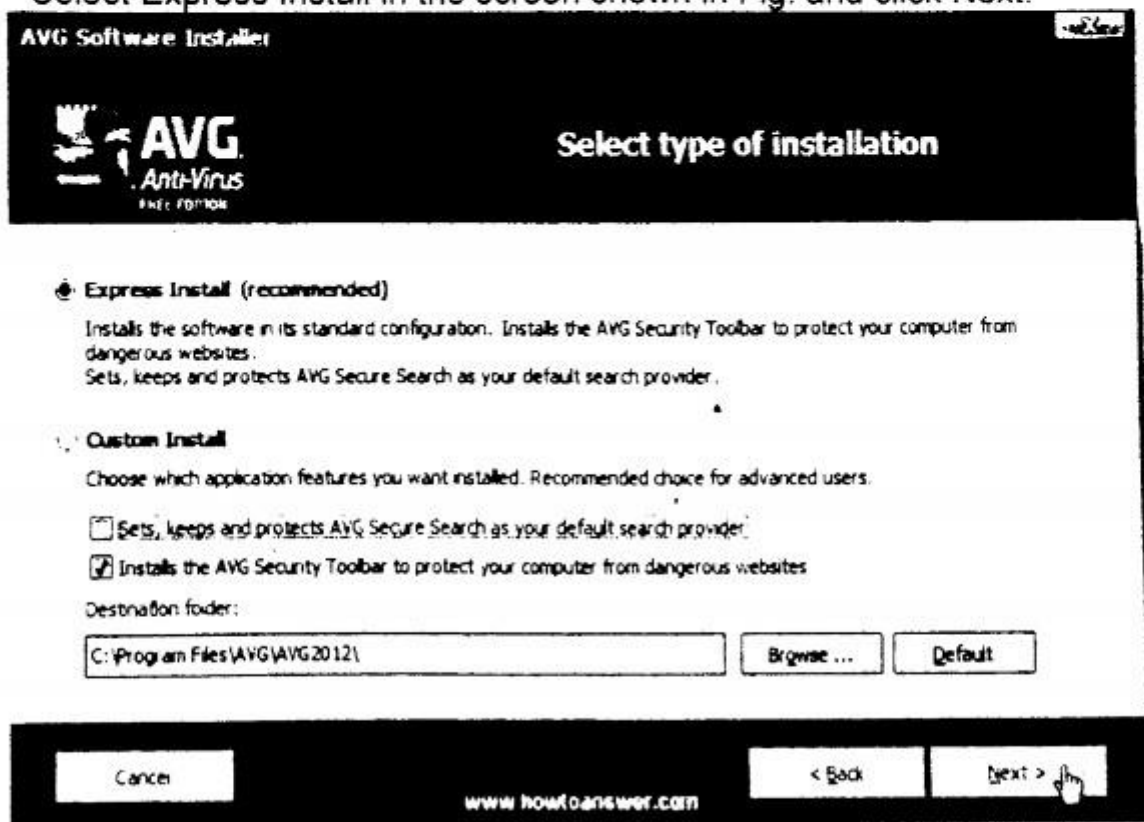

Screen to select type of installation

6. Click Next to accept the default Component Selection shown in the screen of Fig.

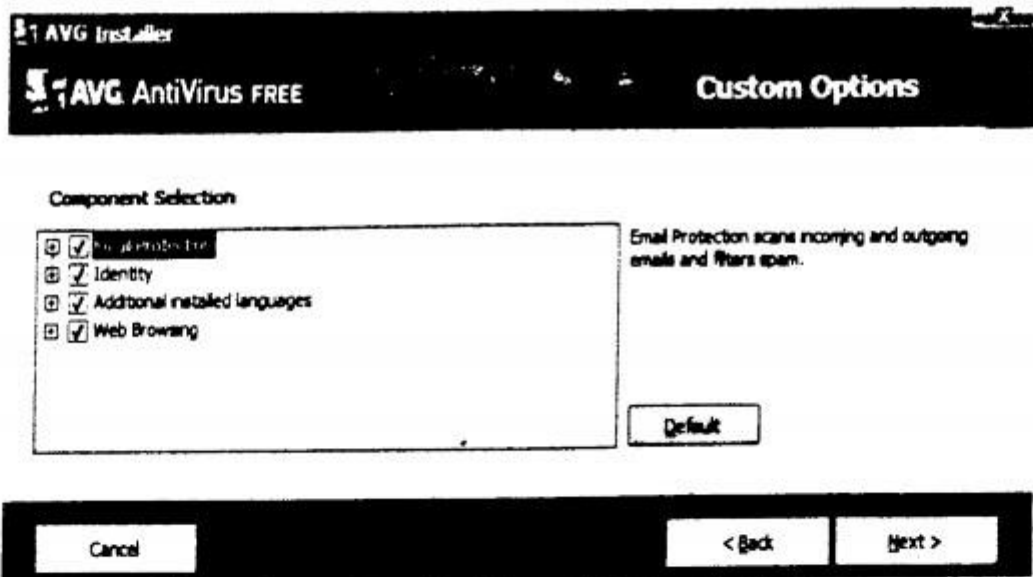

Screen to select custom options

7. Tick (✓) the option in the screen of Fig. if required and click Finish to complete the installation.

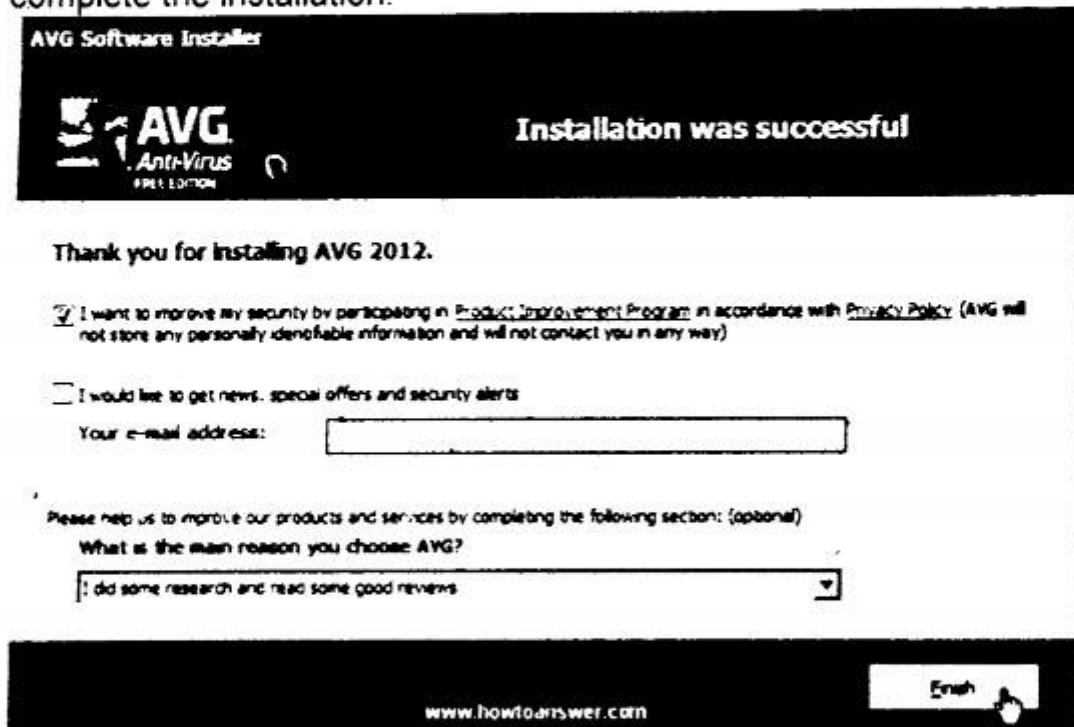

Screen to finish the installation

Do you Know?

The first antivirus software was developed by Bernd Fix in early 1987 to remove Vienna virus.

Q.13 What are the objectives of windows defender?

Ans: Windows Defender:

Windows 10 comes with Windows Defender which is anti-virus software. Now, computer users do not have to buy anti-virus software.

When Windows 10 is installed on a computer, Windows Defender is also installed as built-in anti-virus software. It runs in the background and checks for viruses. It automatically scans programs and files that user opens or downloads.

If any type of malware is detected, it will display warning message and recommend what to do next to keep the computer safe.

KEY POINTS

- Operating System is a collection of system software that controls the working of computer system and acts as an interface between the computer user and computer.
- The main objectives of operating system are convenience and efficiency. It makes the computer more convenient to use.
- Memory Management is the process of allocating memory space for user programs in main memory and managing it.
- Input/output Management is the process of controlling the operation of all the input/output devices attached to computer.
- File Management System is the part of operating system that organizes, stores and keeps track of computer files and folders.
- Resource Management refers to the automatic management of resources of a computer by the operating system when application programs are executed by computer user. Resources of a computer are CPU, memory, input/output devices, etc.
- User Management is an important feature of operating system for creating and managing user accounts for a secure computer system.
- Command Line Interface (CLI) is a type of computer interface that is based on textual input. In CLI, commands are given with a keyboard.
- Menu Driven Interface presents a menu on the screen and the user makes a choice and then the next menu appears. The user makes another choice and so on to operate the computer.
- GUI is a graphical interface for computer users to interact with computer. It uses windows, icons, menus and pointer. To perform a task, the user has to select icons or make choices in menus using a mouse.
- The operating system that is used by a single user at a time is known as Single user Operating System. It is used in microcomputers.
- Multi-user Operating System allows many users to use a computer at the same time. These are used on large computers such as minicomputers and mainframes. They manage a large number of users.
- Batch Processing System groups jobs in batches and the computer executes them one by one.
- Time-sharing System is a feature of operating system in which multiple users can run different programs on a large-scale computer. It allows many users to have access to a computer at the same time and share the computer's time.
- Real-time System must process information and produce a response within a specified time. It is developed for special applications.
- Recycle Bin is a temporary place (folder) for items that the user deletes from the hard disk. Deleted items can be restored if required.

- Computer icon allows the user to access the contents of computer drives and manage files and folders.
- Folder icon resembles a physical file folder and it is used to store files.
- In a GUI files are represented by file icons. A file can be easily recognized by looking at its icon. It opens by double-clicking on it.
- Program icons represent executable program files. They open when the user Double - clicks on them.
- Shortcut icons are created to access a program, file or folder quickly. They have an arrow at bottom left corner and the name below it.
- Managing Data means storing files in secondary storage devices such as hard disk or USB flash drive, in an organized way in folders so that they can be accessed easily and quickly when needed.

EXERCISE

- Q1. Select the best answer for the following MCQs.**
- i. Which interface is based on textual input?**

A. GUI	B. CLI
C. Menu-driven interface	D. Windows
 - ii. Which of the following interface uses window, icon, menu and pointer to interact with computer?**

A. GUI	B. CLI
C. Menu-driven interface	D. DOS
 - iii. Which of the following operating system was introduced in 1969?**

A. Macintosh	B. Linux
C. Unix	D. Windows
 - iv. Which of the following operating system must process information and produce a response within a specified time?**

A. Batch Processing System	B. Time-sharing System
C. Multiprogramming System	D. Real-time System
 - v. Which of the following is open source operating system?**

A. UNIX	B. Linux
C. DOS	D. Novell's Netware
 - vi. Which of the following user interface is the easiest one to learn and use?**

A. CLI	B. GUI
C. Menu driven interface	D. DOS
 - vii. Which of the following operating system allows many users to use a computer at the same time?**

A. Single-user operating system	B. Batch processing system
C. Real-time processing system	
D. Multi-user operating system	
 - viii. In which of the following operating system, CPU is switched rapidly between all the programs to simultaneously execute all of them?**

A. Batch Processing System	B. Time-sharing System
----------------------------	------------------------

- Computer icon allows the user to access the contents of computer drives and manage files and folders.
- Folder icon resembles a physical file folder and it is used to store files.
- In a GUI files are represented by file icons. A file can be easily recognized by looking at its icon. It opens by double-clicking on it.
- Program icons represent executable program files. They open when the user Double - clicks on them.
- Shortcut icons are created to access a program, file or folder quickly. They have an arrow at bottom left corner and the name below it.
- Managing Data means storing files in secondary storage devices such as hard disk or USB flash drive, in an organized way in folders so that they can be accessed easily and quickly when needed.

EXERCISE

- Q1. Select the best answer for the following MCQs.**
- i. Which interface is based on textual input?**

A. GUI	B. CLI
C. Menu-driven interface	D. Windows
 - ii. Which of the following interface uses window, icon, menu and pointer to interact with computer?**

A. GUI	B. CLI
C. Menu-driven interface	D. DOS
 - iii. Which of the following operating system was introduced in 1969?**

A. Macintosh	B. Linux
C. Unix	D. Windows
 - iv. Which of the following operating system must process information and produce a response within a specified time?**

A. Batch Processing System	B. Time-sharing System
C. Multiprogramming System	D. Real-time System
 - v. Which of the following is open source operating system?**

A. UNIX	B. Linux
C. DOS	D. Novell's Netware
 - vi. Which of the following user interface is the easiest one to learn and use?**

A. CLI	B. GUI
C. Menu driven interface	D. DOS
 - vii. Which of the following operating system allows many users to use a computer at the same time?**

A. Single-user operating system	B. Batch processing system
C. Real-time processing system	
D. Multi-user operating system	
 - viii. In which of the following operating system, CPU is switched rapidly between all the programs to simultaneously execute all of them?**

A. Batch Processing System	B. Time-sharing System
----------------------------	------------------------

- C. Real-time System
D. DOS
- ix. **Which of the following Windows icon allows user to access a program, file or folder quickly?**
A. Program icon
B. Computer icon
C. Shortcut icon
D. Recycle Bin icon
- x. **Which of the following Windows icon allows user to access the contents of computer drives and manage files and folders?**
A. Program icon
B. Computer icon
C. Shortcut icon
D. Recycle Bin icon

Answers

i. B	ii. A	iii. C	iv. D	v. B
vi. B	vii. D	viii. B	ix. C	x. B

Q2. Write short answers of the following questions.

i. **Why operating system is important software for a computer? Give any five reasons.**

Ans: Functions of operating system:

The following are the main functions of operating system.

- Process Management
- Memory Management
- Input/Output Management
- File Management
- Resource Management
- User Management

Due to these reasons operating system is important software for a computer.

ii. **Give any three objectives of operating system?**

Ans: Objectives of operating system (OS):

The main objectives of the operating system are convenience and efficiency. It makes the computer more convenient to use. It allows computer resources such as CPU, memory, input/output devices and Internet to be used in an efficient manner. It can be viewed as a resource manager.

iii. **Mention few disadvantages of using DOS.**

Ans: User must know the syntax of the command. DOS commands are difficult to remember. It is a single user and single task operating system.

Its character base interface therefore cannot support graphics. Its cannot use easily as Graphics user interface.

iv. **Name two operating systems which are used in modern mobile phones.**

Ans: Popular Mobile Operating Systems:

- Android OS (Google Inc.)
- Bada (Samsung Electronics)
- BlackBerry OS (Research In Motion)
- iPhone OS / iOS (Apple)
- MeeGo OS (Nokia and Intel)
- Palm OS (Garnet OS)
- Symbian OS (Nokia)

- webOS (Palm/HP)

v. What difficulties a student may face if he/she is not familiar with the operating system of a computer?

Ans: Computer user must know how to give commands to the computer to operate it properly

Computer user must know basic knowledge about operating system. It teaches the user how to use the operating system to run programs and manage files and folders.

Without basic knowledge about operating system, a computer is useless.

Student may face difficulties of the steps involved in installation of operating system, office automation software and antivirus software in computer.

Therefore a student must familiar with the operating system of a computer.

vi. Define UNIX and Windows operating system.

Ans: UNIX:

UNIX Operating System:

UNIX is a multi-user CLI operating system introduced in 1969. It allows multiple users to run different programs at the same time. UNIX was developed for use on large computer system (Mainframe). It uses a command line interface but later Graphical User Interface was also introduced. UNIX commands are shown in Fig.

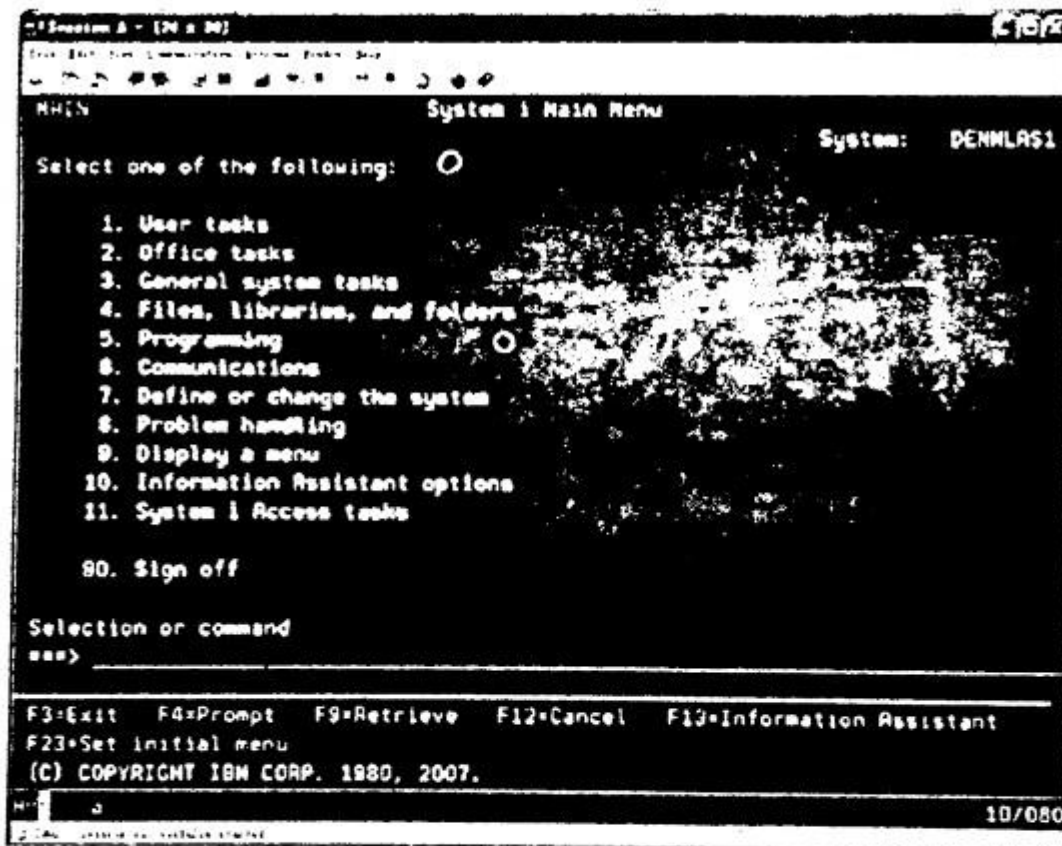

UNIX Interface

Windows Operating System:

Windows is the most popular operating system used on microcomputers. It was developed by Microsoft. Many different versions of Windows operating system were developed and used successfully in the past. Some of these versions are

Windows 95, Windows 98, Windows Millennium, Windows XP, Windows Vista, Windows 7, 8 and 10. The latest version is Windows 10.

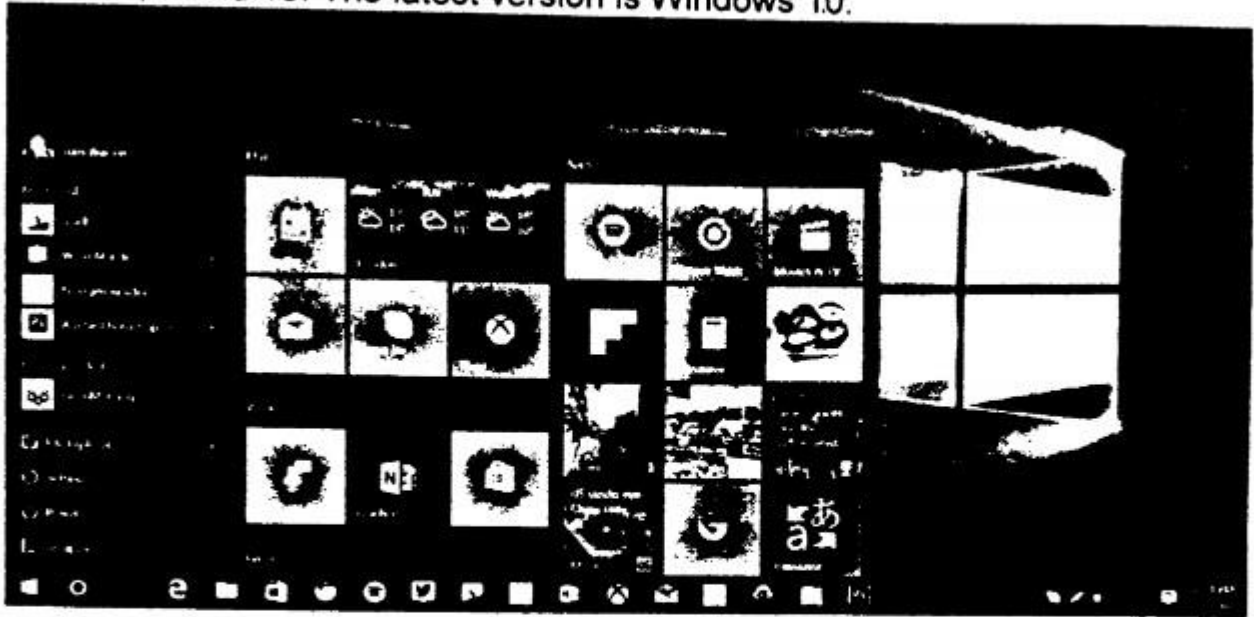

Windows 10 Interface

vii. Differentiate between single-user and multi-user operating systems.

Ans: Difference between single-user and multi-user operating systems:
Single-user Operating System:

Operating system that is used by a single user at a time is known as single-user operating system.

- It allows a single user to login and use the computer at a time. It is easy to use.
- Resources of the computer, such as CPU, memory and input/output devices are not shared with other computers.
- It is used on microcomputers.
- User can open many programs at the same time and switch among them as required.
- It requires less memory and costs less.
- Some examples of single-user operating systems are DOS, Windows 95, Windows XP, Windows 7, etc.

Multi-user Operating System:

Operating system that allows many users to use a computer at the same time is known as multi-user operating system.

- It allows many users to login to a single big computer and run different programs at the same time.
- It shares the resources of the computer with other users over the network.
- It is used on minicomputers and mainframes.
- Users can communicate with each other and share files.
- A person known as administrator is responsible for assigning and managing user names and passwords.
- It requires a powerful CPU, large memory and large hard drives.
- It supports multiprogramming and time-sharing.
- Windows NT, UNIX and Linux are popular multi-user operating systems.

viii. What is meant by managing data and why is it important?

Ans: Managing Data (Files/Folders):

Managing data means storing files in secondary storage devices such as hard disk or USB flash drive in an organized way. This helps in finding files easily and quickly. Files are stored in folders. The Document folder in Windows is the default folder where the user saves files.

File management tools of GUI operating system provide facilities to quickly and easily create folders and copy or move files into them. It also allows the user to delete files and folders that are not needed any more.

ix. What is meant by resources of computer?

Ans: Resource of computer:

Operating system automatically manages the resources of a computer when application programs are executed by computer user.

The resources of a computer include microprocessor, memory and all the devices attached to the computer. Operating system allocates resources of a computer to the application program according to the user's requirement in an efficient way to improve the performance of the computer.

x. What types of problems may a student face if no antivirus is installed in his/her computer system.

Ans: Problems faced if no antivirus is in installed computer system:

Computer virus will damage data, software, or the computer itself.

A computer virus is a program that literally infects other programs and databases upon contact.

Some of the activities that a virus has been programmed to do are:

- i. Copy themselves to other programs.
- ii. Display information on the screen.
- iii. Destroy data files.
- iv. Erase an entire hard disk.
- v. Lie dormant for a specified time or until a given condition is met.

Q3. Write long answers of the following questions.

i. Explain the main functions of operating system.

Ans: Main Functions of Operating System:

The following are the main functions of operating system.

- | | |
|---------------------------|---------------------|
| ● Process Management | ● Memory Management |
| ● Input/output Management | ● File Management |
| ● Resource Management | ● User Management |

Process Management:

Process management is an essential part of operating system (OS). A process is a program in execution. In computer system multiple processes are executing concurrently or waiting for their turn to be executed. A process in execution needs resources like processing resource, memory and I/O resources. The OS must allocate resources to processes, enable processes to share and exchange information, and protect the resources of each process from other processes.

Memory Management:

Memory management is the process of allocating memory space for user programs in main memory. When programs are run by users, the operating system allocates portions of free memory to programs. When a program is closed, operating system will free the memory portion used by that program for reuse. The operating system automatically loads user programs in available memory space and executes them.

Input/output Management:

Input/output management is the process of controlling the operation of all the input/output devices attached to computer. User communicates with computer through various input/output devices such as keyboard, mouse, monitor printer, etc. Management of these devices is the responsibility of operating system. Operating system uses Input/output controller to manage and coordinate the operation of all the input/output devices.

File Management:

File management system is part of operating system that organizes stores and keeps track of computer files and folders. Computer files can be documents, programs, images, videos, etc. Operating system controls the common operations performed on files. These operations include creating, opening, editing, renaming, moving, copying, deleting and searching files.

Resource Management:

Operating system automatically manages the resources of a computer when application programs are executed by computer user. The resources of a computer include microprocessor, memory and all the devices attached to the computer. Operating system allocates resources of a computer to the application program according to the user's requirement in an efficient way to improve the performance of the computer.

User Management:

User management is an important feature of operating system for maintaining a secure computer system. The operating system gives full control over a computer system to a person known as administrator. Administrator installs various programs on the computer system for users. He also creates and manages user accounts. When a user account is created, the user is assigned a user name and a password. Administrator allows the users to run various application programs that are installed on the computer. A user can login to the computer system by entering the user name and password, run programs and save his files in his personal folder. Operating system does not allow the users to install programs or create new users.

ii. **Describe the following computer interfaces.**

- a) **Command Line Interface**
- b) **Graphical User Interface**
- c) **Menu-driven Interface**

Ans: a) Command Line Interface:

In CLI, commands are given to computer with keyboard. It is based on textual input. The user types in a command and presses the Enter key to execute it. Two commonly used operating systems that use CLI are DOS (Disk Operating

System) and UNIX. CLI is difficult to use because users have to remember the commands to perform any task.

b) Graphical User Interface:

GUI is a graphical interface for computer users to interact with computer. It uses windows, icons, menus and pointer. Window is a rectangular portion of monitor in which information is displayed. Icon is a graphical symbol that represents a file, folder, program, device, etc. To perform a task, the user has to select icons or make choices in menus using a pointing device such as mouse.

The following are the advantages of GUI.

- i. Much easier to learn and use
- ii. No need to memorize the commands
- iii. Allows users to run more than one program at the same time
- iv. Most of the GUIs provide good help facilities
- v. Many application programs also use a similar interface so it is easy to use a new program

The following are the disadvantages of GUI.

- i. Takes up lot of memory.
- ii. Needs faster computer as compared to other interfaces.

Examples of operating systems that use GUI are Macintosh, Linux and Windows.

c) Menu-driven Interface:

Menu driven interface presents a menu on the screen, user makes a choice and then the next menu appears. The user makes another choice and so on. Menu driven interface is easy to use as compared to CLI. The user reads the options and makes his choices. Menus contain the commands to use the operating system. Menu driven interface is also used in some application programs and other devices such as mobile phone and iPod.

The following are two common menu driven operating systems

● **Novell's Netware:**

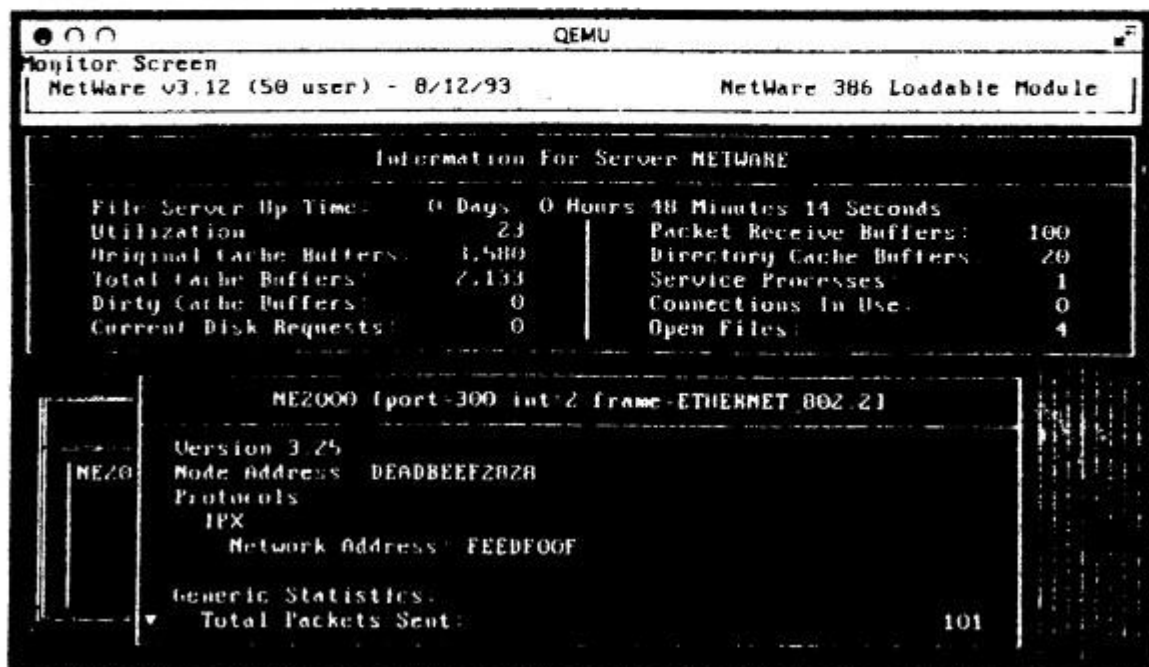

Novell Netware Interface

Novell's Netware was a menu-driven operating system that was used in the past. Its first version was released in 1993. Novell's Netware interface is shown in Fig.

- **ProDOS:**

ProDOS was another menu-driven operating system that was used on some Apple computers. ProDOS interface is shown in Fig.

```

PRODOS BASIC 1.5
COPYRIGHT APPLE 1983-92

ICAT
PRODOS402

NAME                TYPE      BLOCKS  MODIFIED
BASIC.SYSTEM        SYS      21      -DEC-11
COPY.ME             SYS      11      -JUL-11
FASTCOPY.SYSTEM    SYS      41      -MAY-11
LAUNCHER.SYSTEM    SYS      11      -MAY-11
PRODOS              SYS      51      -MAY-11
SETTINGS           SYS      11      -MAY-11
SYSUTIL.SYSTEM     SYS      11      -MAY-11
UTIL.0              SYS      11      -MAY-11
UTIL.1              SYS      11      -MAY-11
UTIL.2              SYS      41      -MAY-11

BLOCKS FREE:      11      BLOCKS USED      269
  
```

ProDOS Interface

iii. Describe the following types of operating systems.

- Batch Processing System**
- Time-sharing System**
- Real-time System**

Ans: a) Batch Processing System:

In a batch processing system, jobs are grouped in batches and the computer executes them one by one. When the current job terminates, the computer automatically loads the next job and starts executing it. Batch processing operating systems greatly improved the use of computer system.

Batch processing systems are suitable for tasks where large amount of data has to be collected and processed on a regular basis.

For example, in credit card billing systems, all the data of credit card holders is collected and held until processed as a batch at the end of billing cycle. As another example, in examination report card system, all the data of student's examinations is collected and processed as a batch for printing report cards.

b) Time-sharing System:

Timesharing system is a feature of operating system in which multiple users can run different programs on a large-scale computer, It allows many users to have access to a computer at the same time and share the computer's time. In a timesharing system, the central processing unit is switched rapidly between the programs so that all the user programs are executed simultaneously.

The operating systems used in minicomputers and mainframe computers support timesharing. Timesharing operating systems are used in organizations such as airline, bank, hotel, university, etc. where many users need access to the central computer at the same time.

For example, hundreds of students access the university's mainframe computer at the same time and they run different programs in a timesharing system in interactive mode.

c) Real-time System:

Real time operating systems must process information and produce a response within a specified time. These operating systems are developed for special applications.

These are used to control industrial processes such as oil refining. Real time operating systems are used to supply immediate response within limited time. For example, a measurement from an oil refinery indicating that temperatures are getting too high might demand quick response to avert an explosion.

There are a number of real-time operating systems used in military and space research programs.

For example, real-time operating system is used to monitor the position of rocket in the space. Many cities are installing real-time traffic control systems to facilitate smooth flow of traffic at busy intersections.

iv. Write notes on Macintosh and Linux operating systems.

Ans: Macintosh Operating System:

Mac OS is a series of operating systems developed by Apple Incorporation for their Macintosh computers. It was introduced in 1984 with the original Macintosh computer and has GUI.

The latest version is Mac OS X. It is a UNIX based user-friendly operating system. There are some specialized versions of Mac OS X used on devices such as iPhone, iPod, iPad and new Apple TV. Mac OS X interface is shown in Fig.

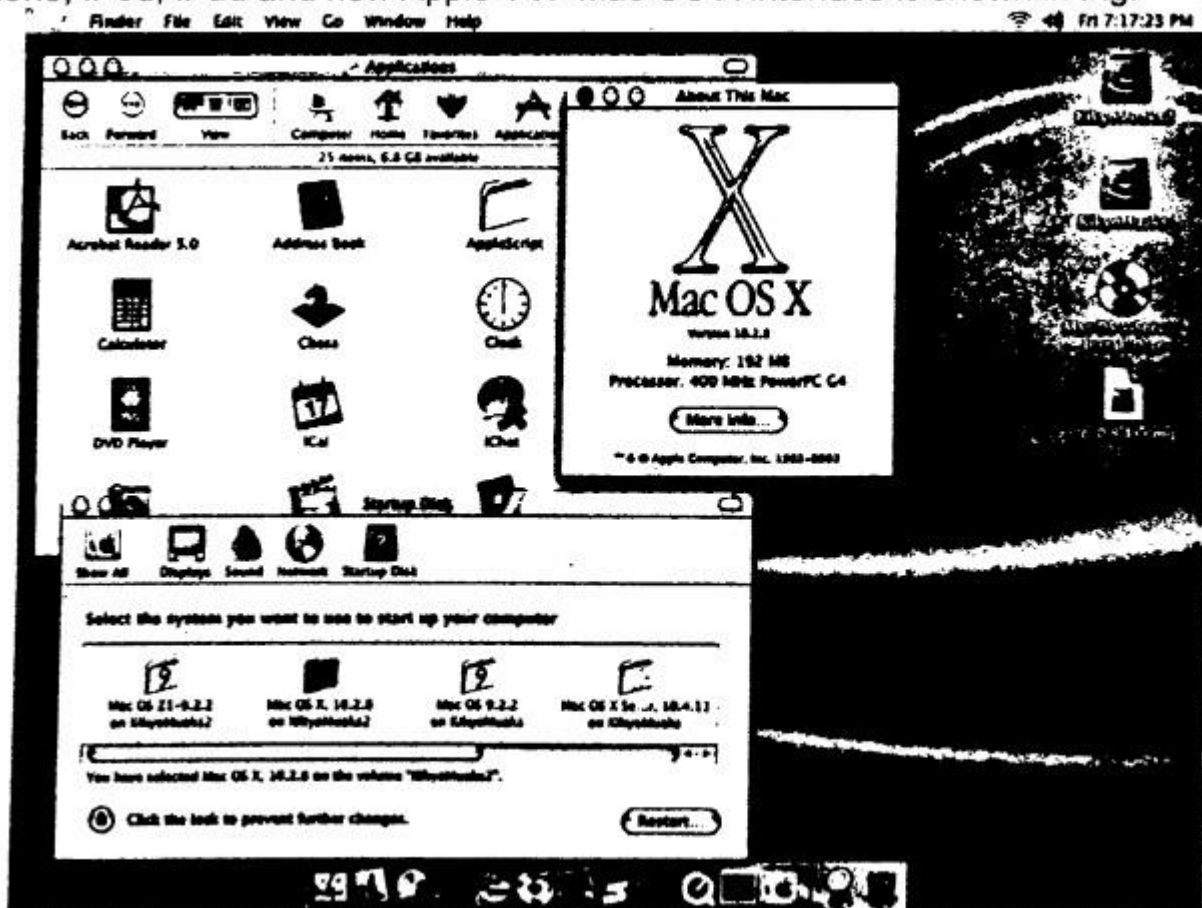

Mac OS X Interface

Linux Operating System:

Linux is free open-source operating system introduced by Linus Torvalds in 1991. It is faster but difficult to use as compared to Macintosh and Windows operating systems. It is not a popular operating system.

Linus Torvalds started the development of Linux operating system and laid its foundation. Millions of programmers around the world work on Linux to improve it.

Its source code is freely available on Internet. Programmers can view, edit and publish an improved version.

Linux OS can be installed on PCs, laptops, netbooks, mobile and tablet devices, video game consoles, servers, supercomputers and more. The Linux OS is frequently packaged as a Linux distribution for both desktop and server use, and includes the Linux kernel (the core of the operating system) as well as supporting tools and libraries.

Popular Linux OS distributions include Debian, Ubuntu, Fedora, Red Hat and openSUSE. Linux operating system interface is shown in Fig.

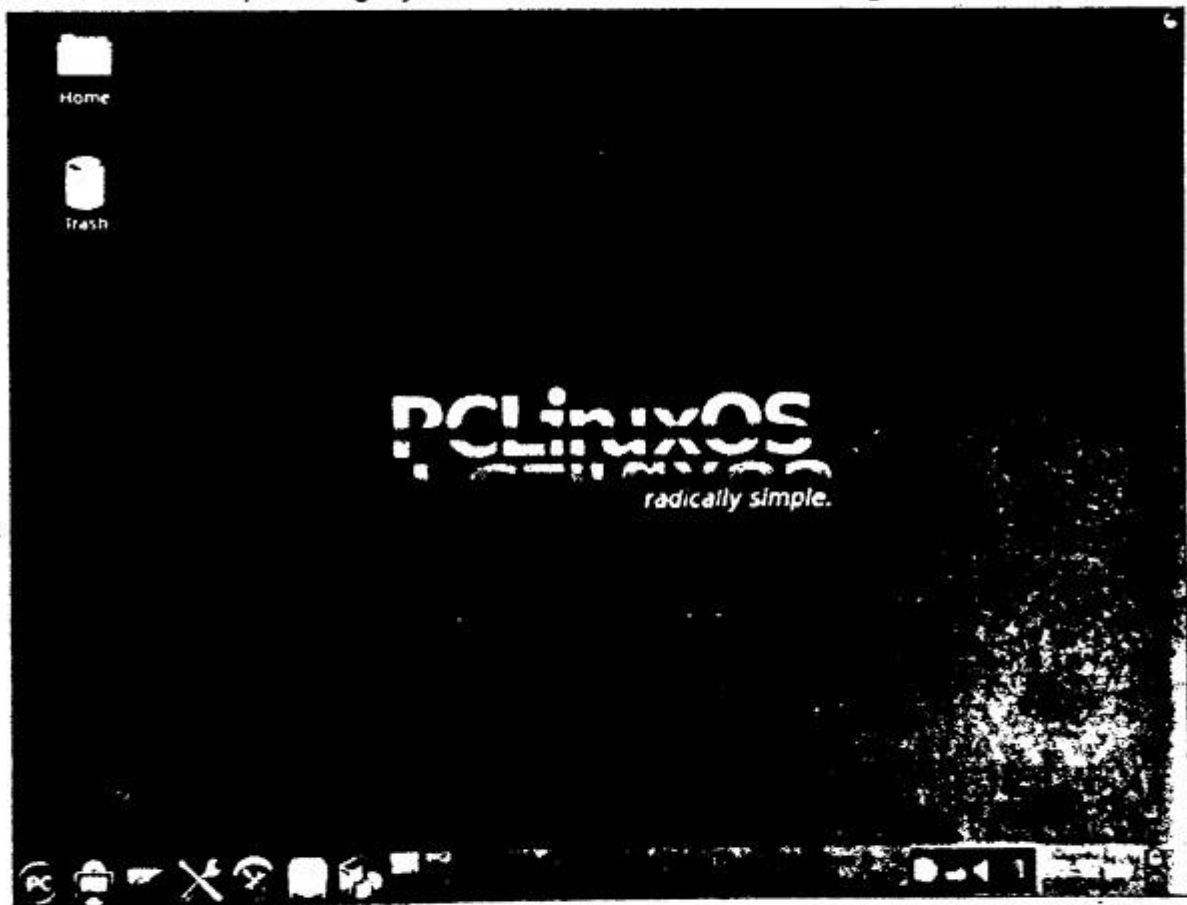

Linux Interface

v. Describe the basic icons of Windows operating system.

Ans: Basic Icons of GUI operating System/basic icons of Windows operating system:

An icon is a small graphical symbol that represents a file, folder, application or device. There are some special system icons such as Recycle Bin and Computer that are kept on the desktop. Icon has a label at the bottom describing its name.

The basic icons of Windows 7 are shown in Fig and are described below.



(a) Recycle Bin



(b) Computer icon



(c) Folder icon



(d) File icon



(e) Program icon



(f) Shortcut icons

Recycle Bin:

It is a temporary place (folder) for items that the user deletes from the hard disk. When a file or folder is deleted from a hard disk it goes to the Recycle Bin. The user can restore it to its original location. User can also delete a file or folder permanently from the Recycle Bin. Icon of a Recycle Bin is shown in Fig (a).

Computer Icon:

Computer icon allows the user to access the contents of computer drives and manage files and folders. When user double-clicks on Computer icon, it will open a window similar to the one shown in Fig. that displays the drives present in the computer. It is used to navigate and manage the computer resources.

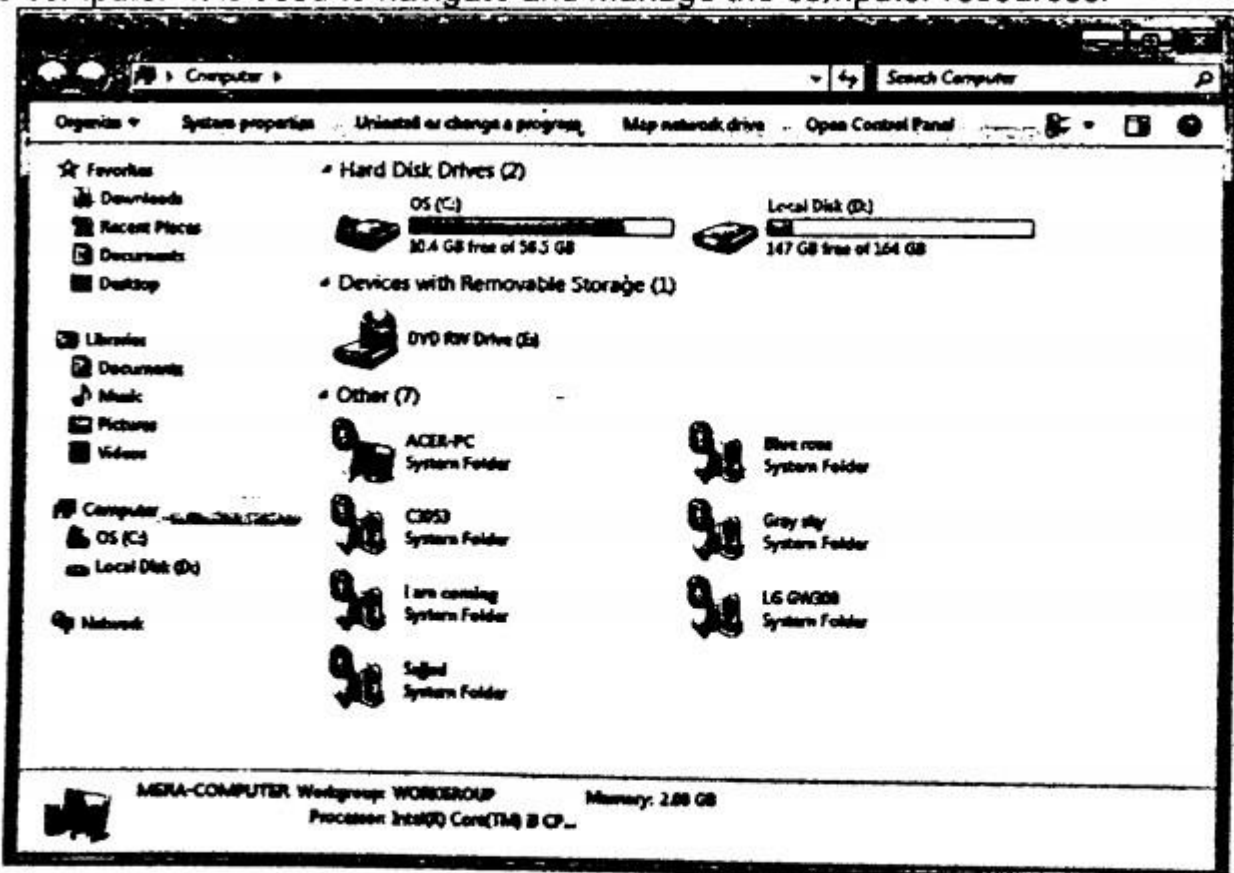

Computer – Icon window

Folder Icon:

Folder icon resembles a physical file folder. It is used to store files. A folder can have another folder inside it which is known as subfolder. Folders are used to keep files in an organized manner on a storage device such as hard disk so that they can be accessed easily.

File Icon:

In a GUI, files are also represented by icons. A file may contain text, image, music or video. Users recognize a file by its icon. Icon of a Microsoft Word file is shown in Fig. (d).

Program Icon:

Executable program files are also represented by icons. Different graphical symbols are used for different program icons. Program icon of Acrobat Reader is shown in Fig. (e).

Shortcut Icon:

Shortcut icons are created to access a program, file or folder quickly. They have an arrow at the bottom left corner and the name below it. Shortcut icon of Google Chrome is shown in Fig. (f).

Lab Activities

Activity 1:

The commonly used commands for using Windows operating system should be demonstrated. Students should be shown how to open and close a program. The commands for setting date and time, adjusting resolution, changing desktop background, color scheme, screen saver, etc. should be demonstrated.

Activity 2:

The file management commands such as create folder, copy, move, delete, rename files and folders are to be demonstrated. Use of Recycle Bin should be demonstrated.

Activity 3:

Installation and un-installation of a program and antivirus software should be demonstrated to students.

EXERCISE

- Q1. Select the best answer for the following MCQs.**
- i. Which of the following software is used for creating professional documents?
A Spreadsheet Software B Word processor
C Typing Tutor D Both A and B
 - ii. Which of the following tab of Word Ribbon contains Clipboard group?
A. Page Layout B. Insert
C. File D. Home
 - iii. By default how many tabs are there in Word Ribbon?
A. 7 B. 8 C. 9 D. 10
 - iv. What is used for creating decorative effects in Word?
A. Paragraph formatting B. Text formatting
C. Page formatting D. WordArt
 - v. Which of the following tab contains the commands for creating charts in Excel?
A. Home B. Formulas
C. Insert D. Data
 - vi. Which of the following command in Excel allows the user to view only certain data in a worksheet based on a condition?
A. Data validation B. Data filtering
C. Conditional formatting D. Data manipulation
 - vii. Which of the following command in Excel restricts user from entering wrong data in cells of a worksheet?
A. Data validation B. Data Filtering
C. Conditional formatting D. Data manipulation
 - viii. Which of the following command is used to apply formatting to one or more cells based on the value of the cell?
A. Data validation B. Data filtering
C. Conditional formatting D. Data manipulation
 - ix. Which of the following shortcut keys are used for pasting selected text?
A. Ctrl+C B. Ctrl+X
C. Ctrl+V D. Ctrl+F
 - x. Which of the following command is used in Word to select the entire document?
A. Double-click B. Triple click
C. Ctrl+Single click D. Shift+Single click

Answers

i. B	ii. D	iii. C	iv. D	v. C
vi. B	vii. A	viii. C	ix. C	x. B

Q2. Write short answers of the following questions.

i. What is a word processor? Write some advantages of it over a typewriter.

Ans: Word Processing:

Word processing refers to the use of computer to create, edit, format and print documents.

Word Processor:

Word processor is computer application software that is used for the creation of different types of documents on computer.

Word processor is a commonly used application of computer. Word processor allows user to delete, modify and rearrange document without retyping any of the existing text.

Microsoft Word:

A common word processing program used is Microsoft Word. It is a part of Microsoft Office software. Microsoft Office contains word processing, record-keeping, spreadsheet and presentation software.

Advantages of using a word processing program over a Typewriter:

- | | |
|--|------------------------------|
| i. We can delete mistakes | ii. Spell-check |
| iii. Different fonts. | iv. Different sizes |
| v. Different color | vi. Pictures |
| vii. We can save | viii. We can email it |
| ix. We don't have to move something to start a line | |
- All these things cannot be done on a typewriter.

Word processing system has the advantage of reducing time required to prepare documents. It provides features to create appealing professional documents. With word processing programs, user can create many types of documents such as letters, reports, resumes, newsletters, memos, flyers, etc.

ii. Name any three types of documents which can be prepared in Word.

Ans: With word processing programs, user can create many types of documents such as letters, reports, resumes, newsletters, memos, flyers, etc.

iii. Differentiate between page break and section break.

Ans: Page Breaks:

A page break is a marker that tells Word program that the contents which follow are to appear on a new page. Word automatically inserts a page break when the user reaches the end of a page. Page break is inserted in document when user wants to add a new page to the document.

Section Breaks:

A section break also inserts a new page but it allows the user to change the page format without having any effect on the formatting of the previous pages.

For example, section break can be used to break a document into sections having different header and footer for each chapter of a book.

Steps for inserting page break and section break:

The following are the steps for inserting page break and section break.

1. Click the **Page Layout** tab
2. Click the **Breaks** icon to open the drop-down menu shown in Fig.

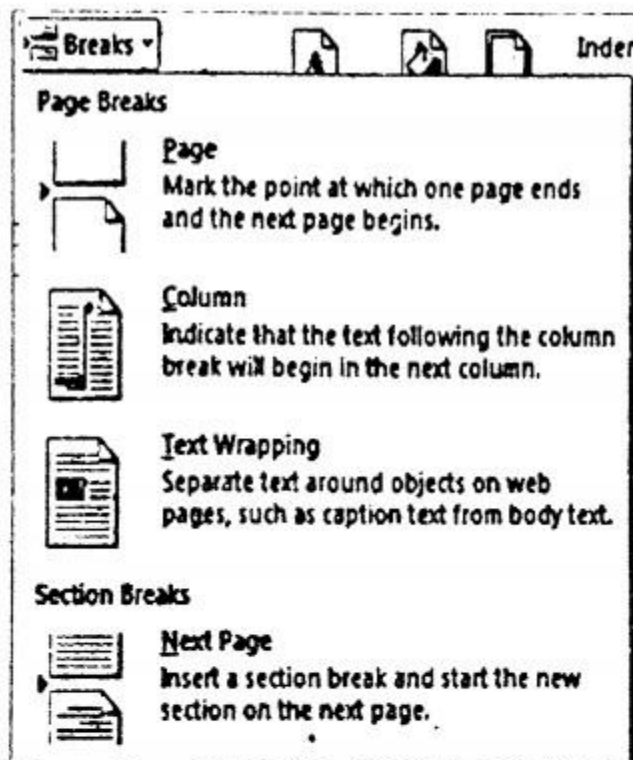

Breaks drop – down menu

3. To insert a page break click the first option under the **Page Breaks** heading and to insert a section break click the first option under the **Section Breaks** heading.

iv. Why header and footer are important in a Word document?

Ans: Header:

Header refers to information that appears at the top of a page

Footer:

Footer refers to information that appears at the bottom of a page.

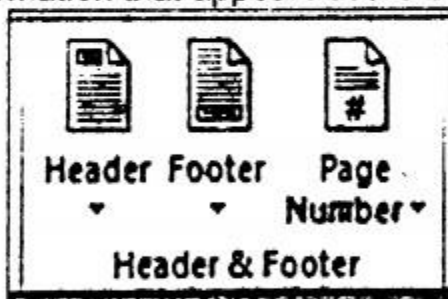

Importance of header and footer:

The type of information that may appear in the header or footer includes book title, document title, chapter number and title, page number, company name, etc.

Steps for inserting header or footer:

The following are the steps for inserting header or footer.

1. Click the **Insert** tab
2. Click the **Header** or **Footer** in the **Header & Footer** group shown above to open the drop-down menu.
3. Select a predesigned header or footer from the drop-down menu shown in Fig.

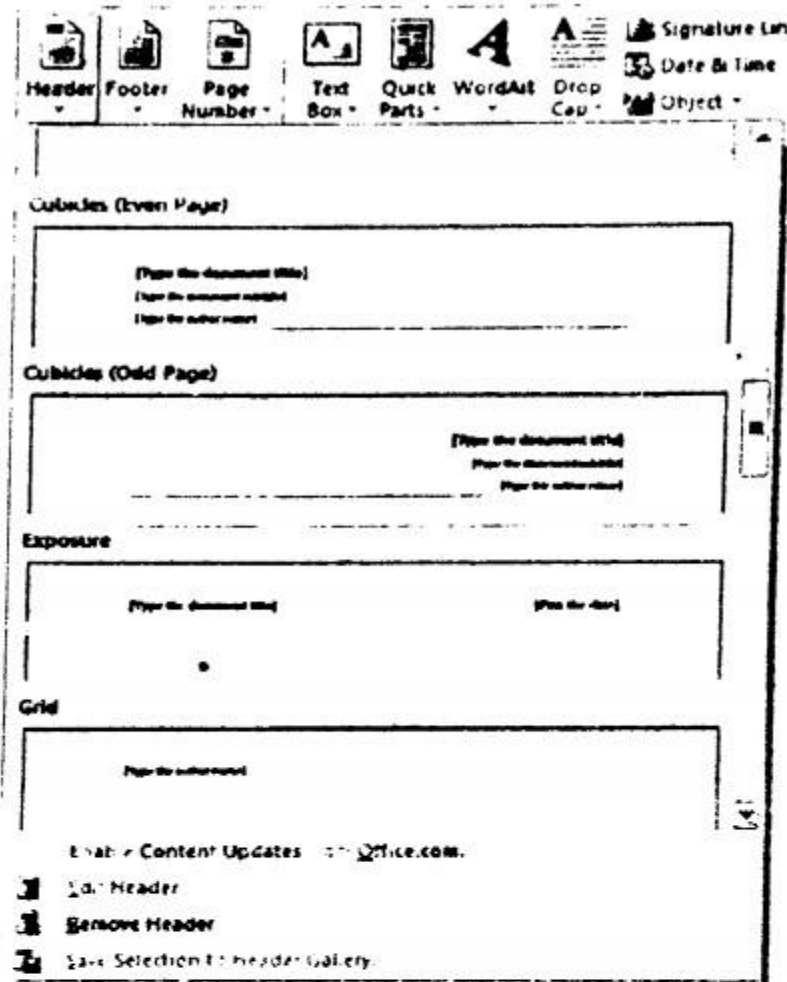

Inserting a header

Header or footer will appear in the document and the **Design** tab will appear in the **Ribbon** as shown in Fig

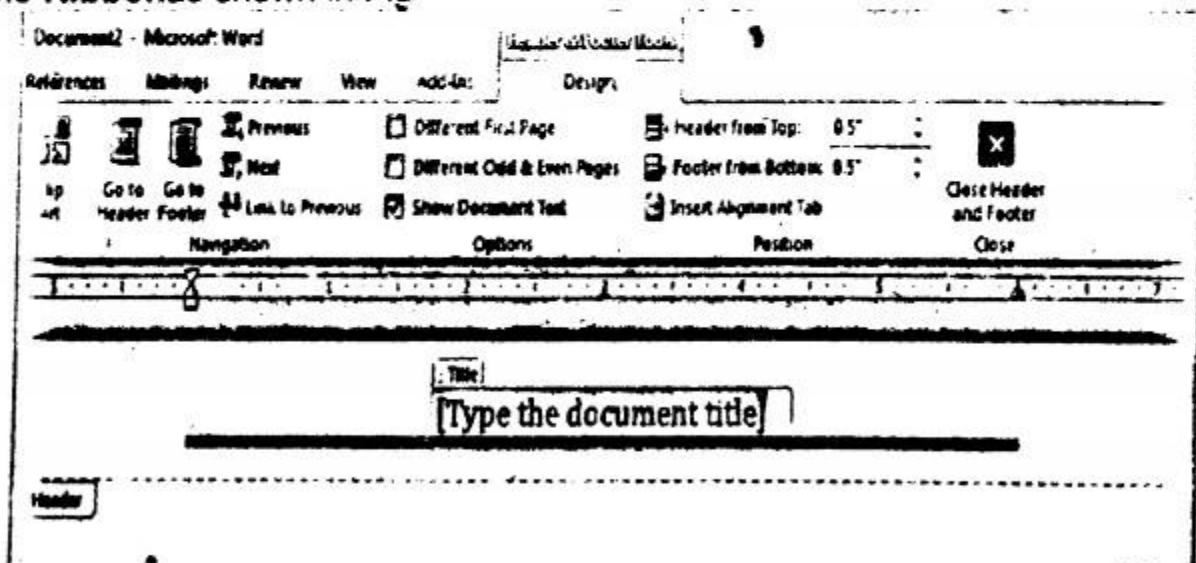

Entering information in header

4. Type the information in the header or footer
5. After entering the information, click **Close Header and Footer** in the **Design** tab
To edit the information in the header or footer Double-click anywhere on the header or footer and make the changes

v. What is the purpose of control buttons in Word window?

Ans: Control Buttons: 

Every window has a set of three control buttons that appear in a row on the right side of the title bar. These are the **Minimize, Maximize/Restore and close buttons** . If you point at one of these buttons, a **control menu** appears telling you the action that can be taken on clicking it.

Minimize button:

You can minimize a window from the view by clicking the **Minimize** button  when currently it is not required but must remain running.

Maximize button:

You can **Maximize**  window by clicking the maximize button that enlarges the window to fill the entire screen.

Restore button:

When a Window is maximized, a **Restore** button  appears in its place. With the **Restore** button you can return the Window to its original size.

Close button:

A window has an associated button having its name with an icon on the taskbar. You can close a window by clicking the **Close** button .

vi. Why hyperlinks are created in Word document?

Ans: You can add hyperlinks to your document that give your readers instant access to information in another part of the same document.

The hyperlink can be text or graphics. By using hyperlinks, you can provide information to your readers without repeating the same information on different pages.

To add links that jump from one part of a document to another part of the same document, mark the destination and then add a link to it.

OR (Second Answer)

A hyperlink is basically a location address inserted into a document that links to another object or location. An object can be a Word file, an HTML web page, an image, sound file, video or other digital file.

The address can also link to a location within the original document, allowing the reader to jump to different sections of the document.

Hyperlinks are clickable and take a user to the target location or object.

Using Hyperlink:

Hyperlink is text in a Web page or document that links to another Web page or another place in the same document when the user clicks on it.

The following are the steps to create a Hyperlink.

1. Select the text that is to be displayed as Hyperlink as shown in Fig.

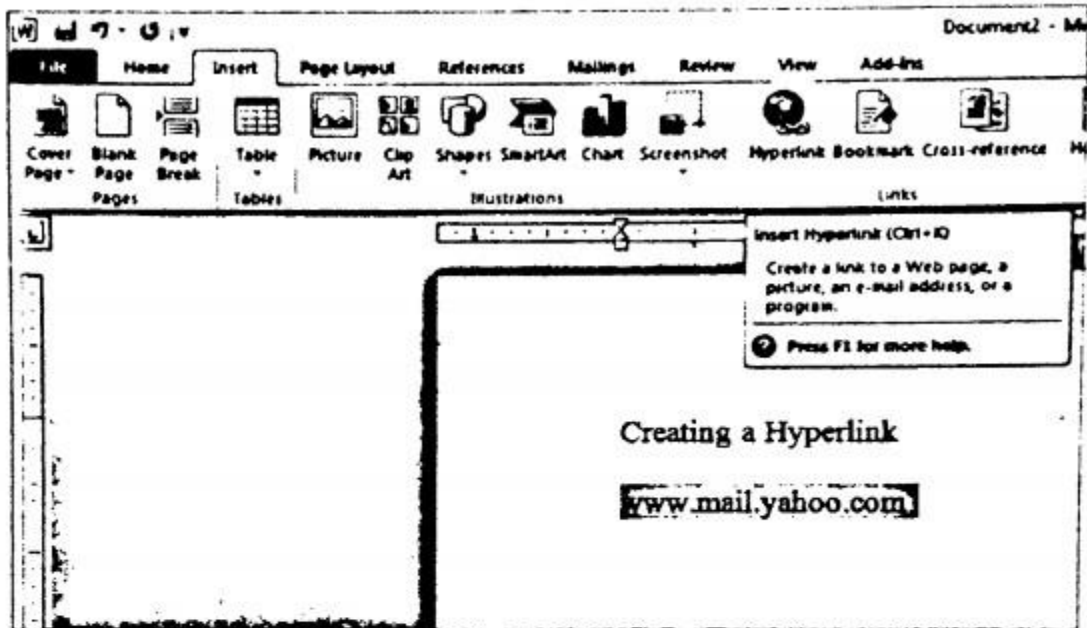

Inserting a Hyperlink

2. Click the **Insert** tab.
3. Click **Hyperlink** in the **Links** group as shown in Fig.

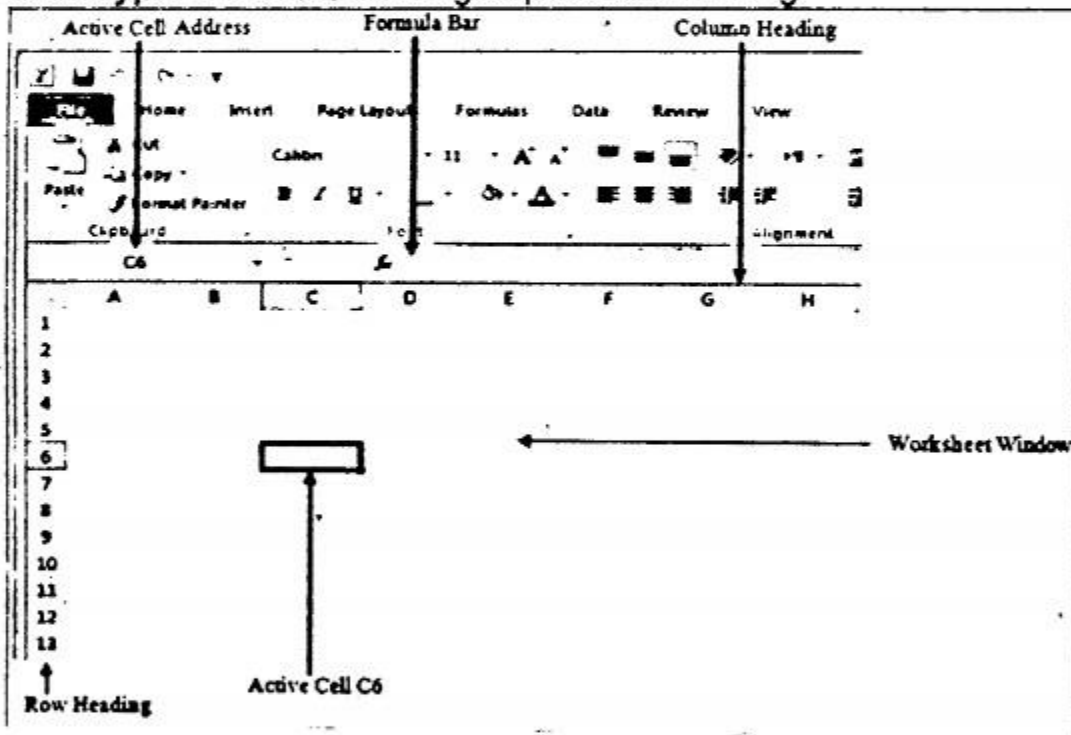

Opening screen of Microsoft Excel

4. Click **OK**.
 There is also an easy way to create a Hyperlink to Web page. Type the Hyperlink text and press Spacebar or Enter key.
 Hyperlink appears in blue color and underlined. To open the Web page, position the mouse pointer over the Hyperlink and press the Ctrl key while clicking the mouse button.
 The text format of Hyperlink can be formatted to regular text, that is, it should not be in blue color or underlined. To remove the text format of Hyperlink, Right-click the Hyperlink and select **Remove Hyperlink** from the shortcut menu.

vii. Name any three areas of application of Excel.

Ans: Excel allows us to perform calculations (like a calculator) and manipulate text (like a word processor).

1) Pivot Tables:

PivotTables summarise large amounts of Excel data from a database that is formatted where the first row contains headings and the other rows contain categories or values.

2) Conditional Formatting:

Conditional formatting helps users to quickly focus on important aspects of a spreadsheet or to highlight errors and to identify important patterns in data.

3) Sorting and Filtering:

Sorting and filtering your data will save you time and make your spreadsheet more effective.

4) Basic Math:

We can type the calculation you want to perform directly into the cell or the formula bar and when you press Enter the answer will show in the cell.

5) Mixed Type Charts:

Mixed type or combo (combination) charts combine two styles of charts, such as Excel's column chart and line chart. This format can be helpful for displaying two different types of information or a range of values that varies greatly.

viii. Differentiate between relative and absolute cell addressing in Excel.

Ans: Relative Cell Addressing:

In Excel, cell addresses included in a formula or function are relative cell addresses. Relative cell address means when a formula is copied to other cells, the cell references in the formula change to reflect the formula's new location.

Explanation:

To understand relative addressing, consider the worksheet shown in Fig.

The screenshot shows an Excel spreadsheet with the following data:

Brand	January	February	March	Total Sales
Acer	34	50	44	128
Toshiba	23	15	28	
Dell	52	58	70	
HP	41	37	55	

The formula bar shows the formula $=B5+C5+D5$ entered in cell E5.

Entering formula in worksheet

- Enter the formula $=B5+C5+D5$ in cell E5 to calculate the total number of Acer laptop computers sold in the first quarter.

- Copy the formula in cell E6.
- The formula in cell E6 becomes =B6+C6+D6 as shown in Fig.

The screenshot shows an Excel worksheet with the following data:

Brand	January	February	March	Total Sales
Acer	34	50	44	128
Toshiba	23	15	28	66
Dell	52	58	70	
HP	41	37	55	

Copying formula to another cell

- The cell references have automatically changed based on the relative position of row and columns because relative cell addressing is used in formula in cell E5.
- Similarly the formula will become =B7+C7+D7 in cell E7 and in cell E8 it will become =B8+C8+D8. This is what is required in this worksheet.

Absolute Cell Addressing:

User can address a particular cell location no matter where the formula appears by using absolute cell address. Absolute cell addressing keeps a cell reference constant when copying a formula or function. Absolute cell addresses begin with a dollar sign in the formula, such as = $\$C\5 + $\$D\5 .

In the worksheet of Fig (a), sales tax is calculated as 6% for software items. Absolute cell addressing is used for the cell C3 in the formula = $C6*\$C\3 in cell D6 for calculating sales tax because it should not change when the formula will be copied to cells D7, D8 and D9 as shown in Fig (b).

The screenshot shows an Excel worksheet with the following data:

S.No.	SOFTWARE TITLE	PRICE	TAX
1	MS Windows 7	Rs. 220.00	=C6*\$C\$3
2	MS Office 2010	Rs. 250.00	
3	Anti-virus Software	Rs. 24.00	
4	Accounting Software	Rs. 75.00	

(a) Using absolute cell addressing in formula

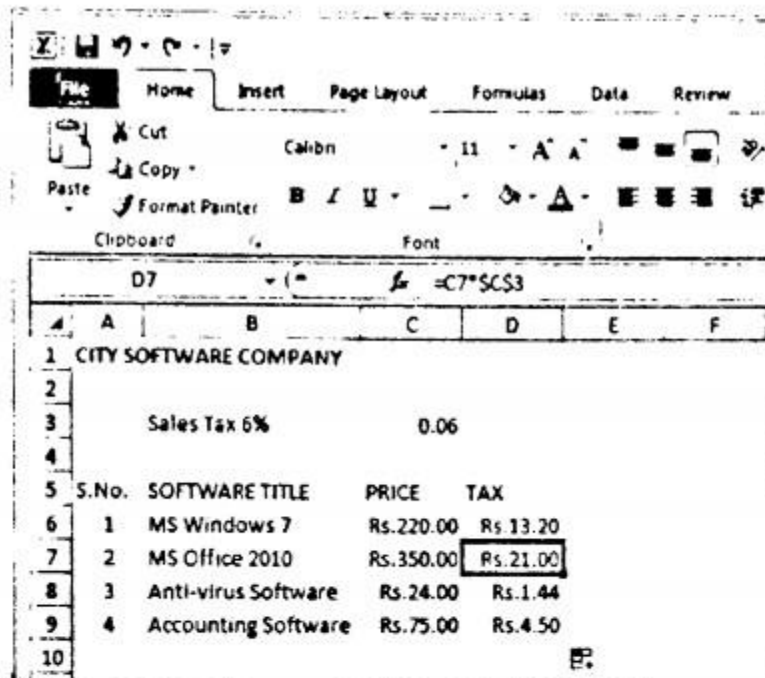

(b) Copying formula that has absolute addressing

ix. **What are the advantages of protecting an Excel worksheet?**

Ans: Protecting an Excel Worksheet:

Sometimes the data in your worksheets contain important information that you may not want others to edit or delete. Fortunately, you can protect sensitive information in elements down to the cell level in Excel.

When a worksheet is protected, other users can only view the information in it but changes cannot be made.

Steps to protect a worksheet:

The following are the steps to protect a worksheet.

1. Click **Review** tab in the **Ribbon**.
2. Click **Protect Sheet** command in the **Changes** group.
3. Enter a password and click **OK**.
4. Re-enter password to confirm and click **OK**.

x. **How graphical representation of spreadsheet data can be helpful in business.**

Ans: A chart is used to represent data graphically. Charts are very helpful in explanation and representation of data. A commonly used chart is the column chart.

Excel allows business users to **unlock the potential of their data**, by using formulas across a grid of cells. Data is inserted into individual cells in rows or columns, allowing it to be sorted and filtered, and then displayed in a visual presentation.

Using pie charts, graphs and clustered columns adds meaning to data, which otherwise may just exist as row after row of numbers. These visualisations can add extra emphasis to business reports and persuasive marketing material.

Q3. Write long answers of the following questions.

i. **Which shortcut keys are used in Word to move cursor to the beginning of line, end of line, top of the document and end of the document?**

Ans: Shortcut keys for cursor movement are shown in Table.

Shortcut keys for cursor movement

Cursor Movement	Shortcut Key
Beginning of the line	Home
End of line	'End
Top of the document	Ctrl + Home
End of document	Ctrl + End

- ii. Write the mouse commands used for selecting various items in a Word document such as single word, sentence, paragraph, etc.

Ans:

Item to Select	Mouse Command
Single word	Double-click the word
Sentence	Press and hold down Ctrl key and click anywhere in the sentence
Paragraph	Move the mouse pointer to the left of the paragraph until it changes to a right-pointing arrow and then Double-click

- iii. Explain text and paragraph formatting in Word.

Ans: **Text Formatting:**

Formatting text means changing the font type, size, style, color and effects of text.

Changing the Font Type and Size of Text:

Open the **Home** tab and click the arrow on the right side of the currently selected font type as shown in Fig, and choose another font type. To change the font size, click the arrow on the right side of the font size and select a font size from the drop-down list or type a new font size. To change the font type or size of existing text, select the text and then make the changes.

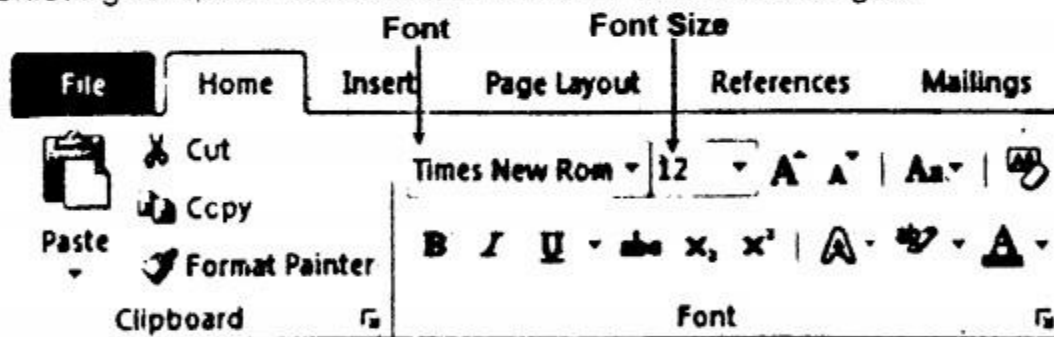

Changing font type and font size

Changing Font Styles and Effects:

The following are the steps for changing font styles and effects.

1. Click the **Home** tab.
2. Click the dialog box launcher on the lower-right corner of the **Font** group. This will open the **Font** dialog box shown in Fig. Now, the user can change font styles and effects of text.

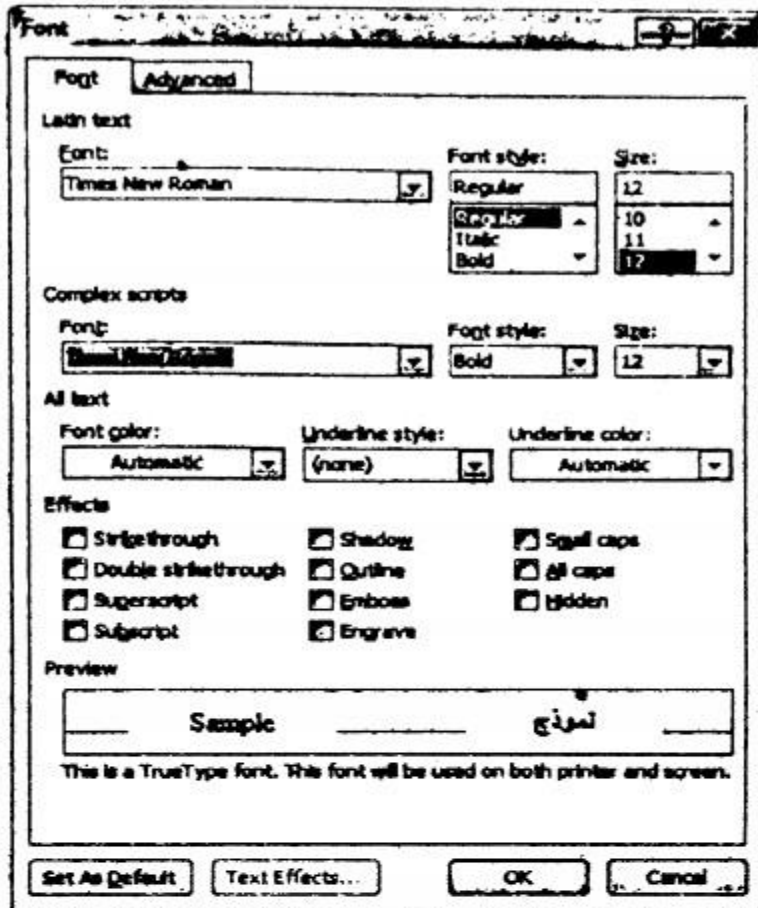

Font dialog box

Some changes that are available in the Font dialog box can be made directly from the Font group in Home tab.

Steps to clear the text formatting:

The following are the steps to clear the text formatting.

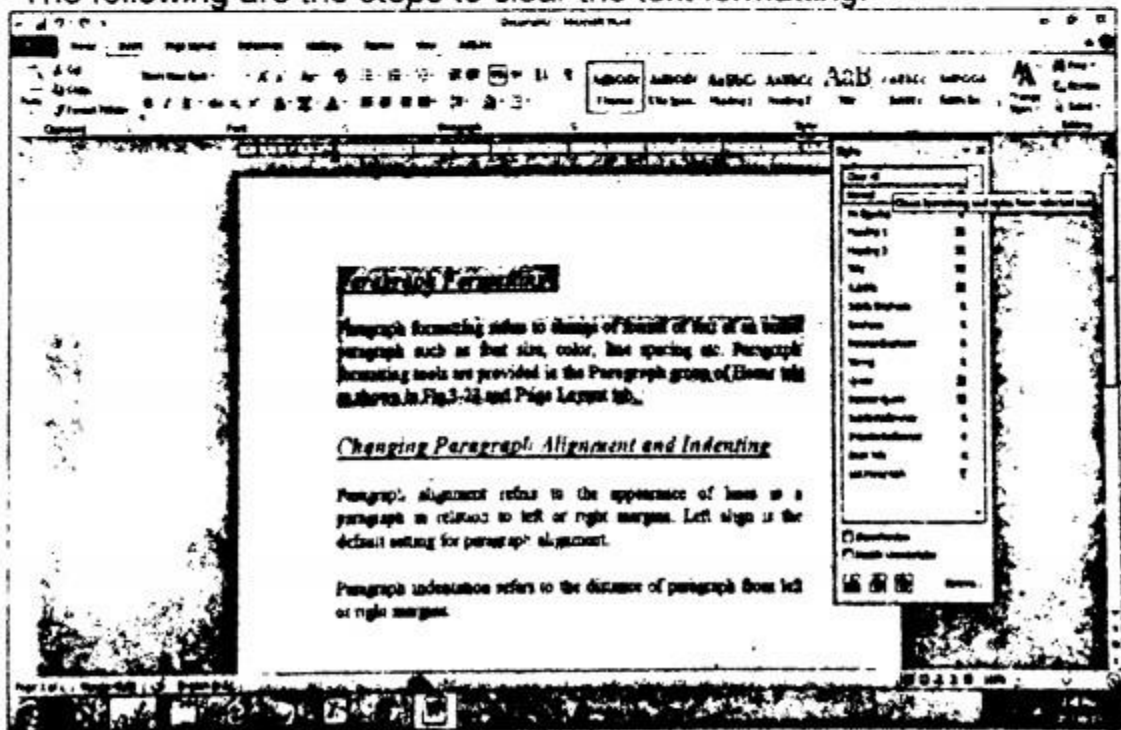

Style dialog box

1. Select the text you want to clear the formatting.
2. Click the **Home** tab.
3. Open the **Styles** dialog box and select **Clear all** as shown in Fig.

Paragraph Formatting:

Paragraph formatting refers to change of format of text of paragraph such as font size, color, line spacing, alignment etc. Paragraph formatting tools are provided in the **Paragraph** group of **Home** tab and **Page Layout** tab.

● **Changing Paragraph Alignment and Indenting:**

Paragraph alignment refers to the appearance of lines in a paragraph in relation to left or right margins. Left align is the default setting for paragraph alignment.

Paragraph indentation refers to the distance of paragraph from left margin.

Select the paragraph to change the alignment and then select an alignment from the **Paragraph** group on **Home** tab as shown in Fig.

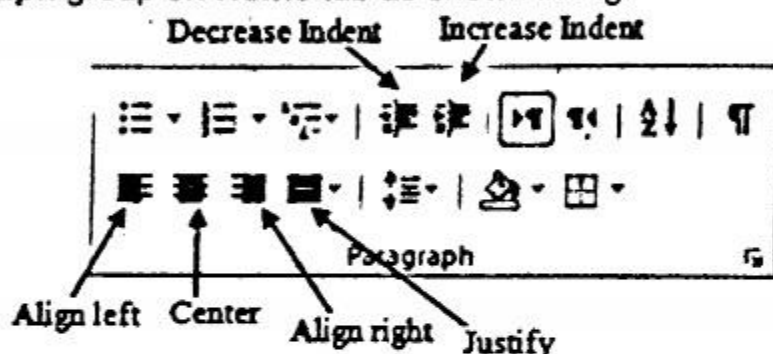

Paragraph alignment and indenting

- Align left:** It will align the text to the left margin.
Center: It will center the text within the left and right margins.
Align right: It will align the text to the right margin.
Justify: It will align the text both to the right and left margins.

To increase paragraph indent, click the **Increase Indent** button shown in Fig, in the **Paragraph** group on **Home** tab. To decrease the paragraph indent, click the **Decrease Indent** button. Increasing indentation will move the paragraph to the right side by one tab position. Decreasing indentation will move the paragraph to the left side by one tab position.

● **Changing Spacing between Paragraphs and Lines:**

The following are the steps for changing spacing between paragraphs and lines

1. Select the paragraph or paragraphs.
2. Click **Home** tab
3. Open the **Paragraph** dialog box shown in Fig, by clicking the small arrow at the bottom right corner of the **Paragraph** group.
4. Make the required changes.
5. Click **OK** to apply the changes.

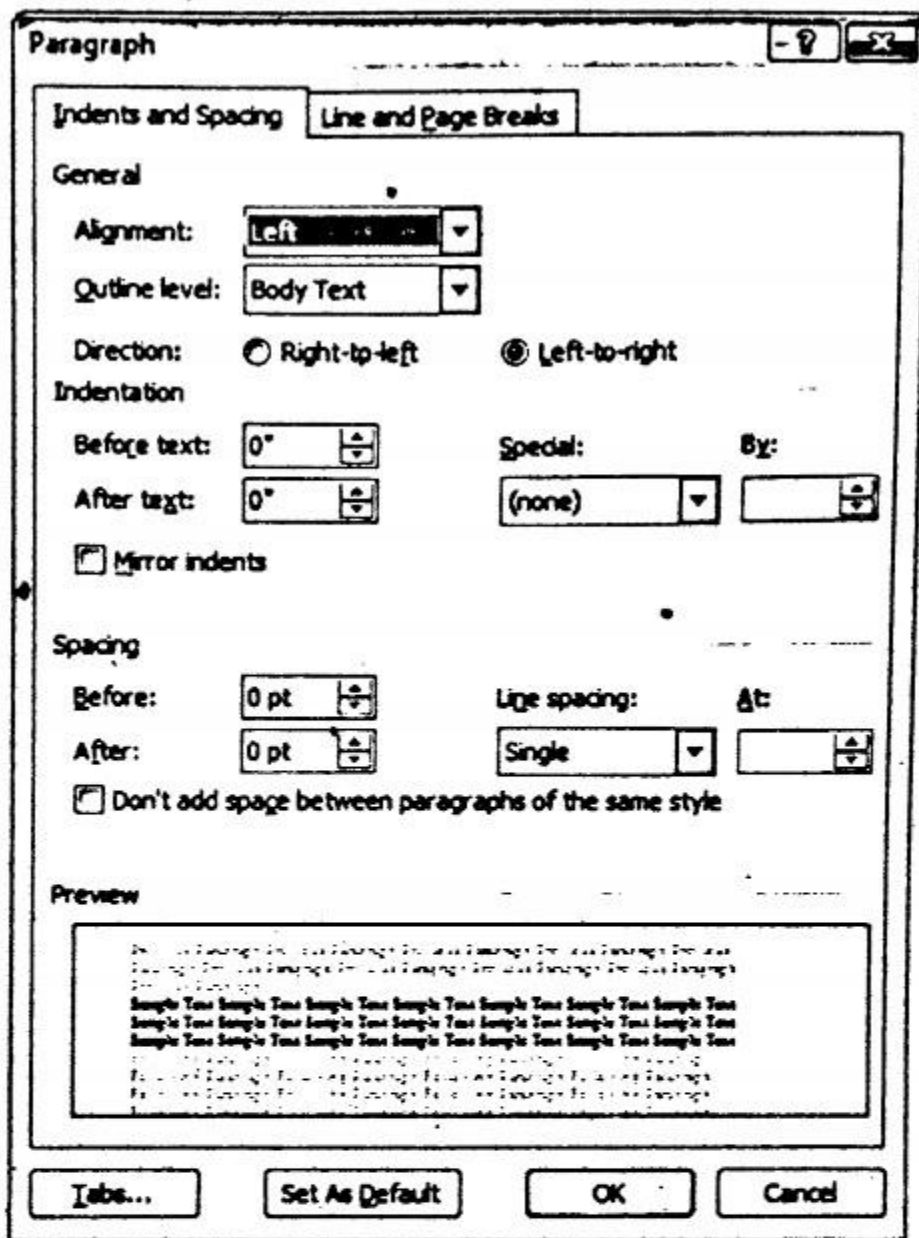

Paragraph dialog box

iv. Describe the Paste Special command used in Excel.

Ans: Paste Special:

Excel copies all the information in the selected range of cells when you paste data.

Excel's Paste Special command allows many other options while pasting cells such as paste only formats of selected cells without contents or paste contents without formulas

Steps describe the use of Paste Special command:

The following steps describe the use of Paste Special command.

1. Select the cell range to paste.
2. Open the Paste drop-down menu in Clipboard group of Home tab and select Paste Special as shown in Fig. Paste Special dialog box will open.

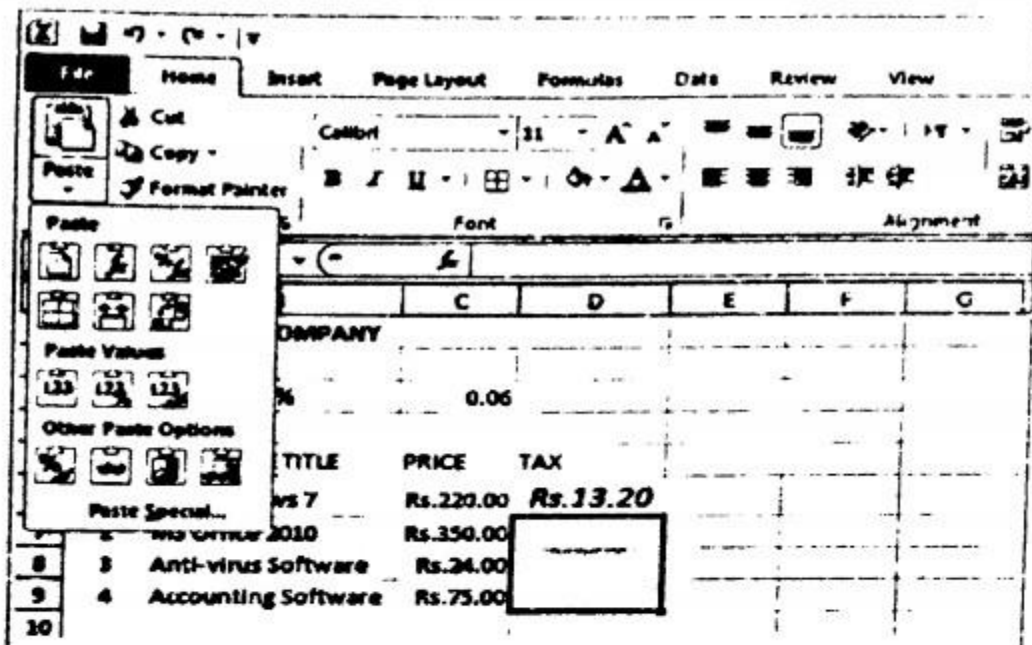

Using Paste Special command

3. Select an option from the **Paste Special** dialog box shown in Fig. and click **OK**.

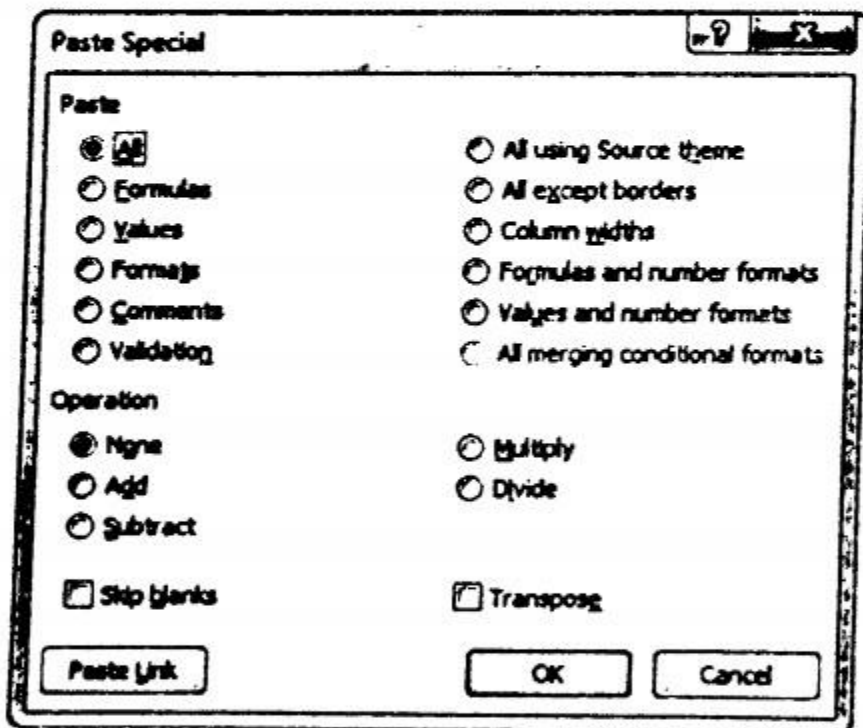

Paste Special dialog box

Commonly used options of Paste Special dialog box:

Commonly used options of Paste Special dialog box are explained below.

All: Used to paste all the information in the selected cell range. This is same as normal paste command.

Formulas: Used to paste text, numbers and formulas without formatting. The formula in cell D6 in the worksheet shown in Fig, is formatted.

D6				
A	B	C	D	E
1	CITY SOFTWARE COMPANY			
2				
3	Sales Tax 6%		0.06	
4				
5	S.No.	SOFTWARE TITLE	PRICE	TAX
6	1	MS Windows 7	Rs.220.00	Rs.13.20
7	2	MS Office 2010	Rs.350.00	
8	3	Anti-virus Software	Rs.24.00	
9	4	Accounting Software	Rs.75.00	
10				

Formula in cell D6 is formatted

When this formula is copied to cells, D7, D8 and D9 using paste special, the format of cell D6 is not copied as shown in Fig.

J18				
A	B	C	D	E
1	CITY SOFTWARE COMPANY			
2				
3	Sales Tax 6%		0.06	
4				
5	S.No.	SOFTWARE TITLE	PRICE	TAX
6	1	MS Windows 7	Rs.220.00	Rs.13.20
7	2	MS Office 2010	Rs.350.00	Rs.21.00
8	3	Anti-virus Software	Rs.24.00	Rs.1.44
9	4	Accounting Software	Rs.75.00	Rs.4.50
10				

Formula in cell D6 is copied to cell D7, D8 and D9

Values: Used to convert formulas in the selected cell range to their calculated values and then apply the paste command.

Formats: Used to paste only the formatting of selected cell range without cell contents.

All except borders: Used to paste all the information in the selected range without copying any borders if used.

v. Describe how functions are used in Excel with examples.

Ans: Working with Functions in Excel:

Functions are built-in formulas in Excel that allow user to easily perform common calculations on data. Functions can be entered in a worksheet using keyboard, Insert Function command or AutoSum drop-down menu.

● **Using Keyboard to Find Average:**

The following are the steps to calculate average sale for Acer laptop computer during the first quarter using the AVERAGE function.

1. Select cell E5 where the result will appear.
2. Type =av to display the Formula AutoComplete list as shown in Fig.

	A	B	C	D	E	F
1	MARGALLA COMPUTER SYSTEMS					
2	First Quarter Laptop Sales					
3						
4	Brand	January	February	March	Average	
5	Acer	34	50	44	=av	
6	Toshiba	23	15	28		
7	Dell	52	58	70		
8	HP	41	37	55		
9						
10						

Calculating average

3. Point to **AVERAGE** function and Double-click.
4. Select the range B5:D5 to insert it as argument to the **AVERAGE** function.
5. Press Enter key.

Using Insert Function command to Find the Highest Value:

The following are the steps to find the highest value.

1. Select cell B11 where the answer will appear.
2. Click **Insert Function** command shown in Fig. Insert Function dialog box will be displayed.

Insert Function command

The screenshot shows the 'Insert Function' dialog box in Microsoft Excel. The dialog box is titled 'Insert Function' and has a search bar. Below the search bar, there is a dropdown menu for 'Or select a category: Most Recently Used'. A list of functions is displayed, with 'MAX' selected. Below the list, the formula 'MAX(number1, number2,...)' is shown, along with a description: 'Returns the largest value in a set of values. Ignores logical values and text.' At the bottom of the dialog box, there are 'OK' and 'Cancel' buttons. An arrow points from the text 'Insert Function command' to the 'Insert Function' button in the dialog box.

Using Insert Function command to insert a function

3. Select **MAX** in the function list and click **OK**.
4. Type B5:B8 in the **Number 1** text box of **Function Arguments** dialog box and click **OK**.
- **Using AutoSum Drop-down Menu to Find the Lowest Value:**
The following are the steps to find the lowest value in the range B5:B8 using **AutoSum** drop-down menu.
 1. Select cell B12 where the answer will appear.
 2. Click **Formulas** tab.
 3. Open the **AutoSum** drop-down menu in the **Function Library** group as shown in Fig. and select **Min**.

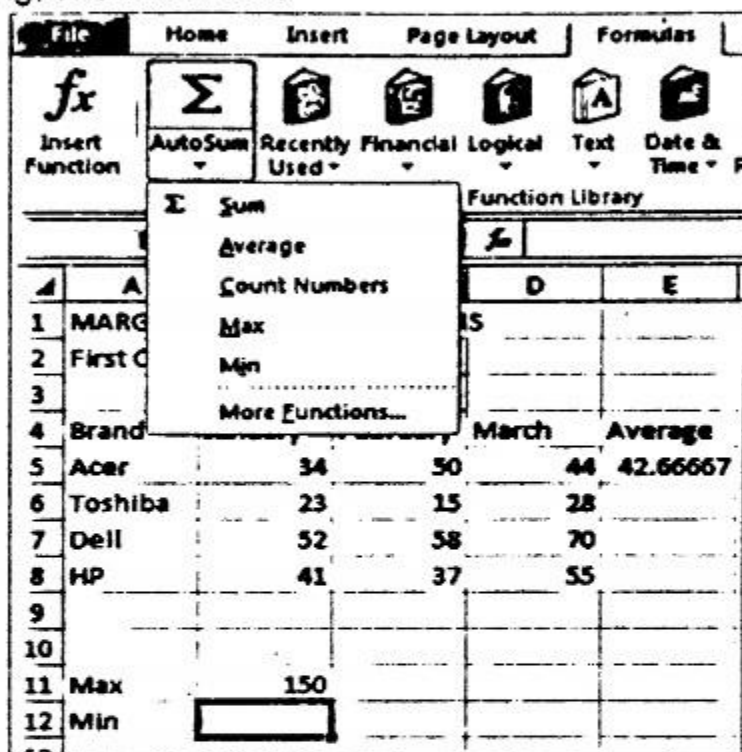

Using AutoSum command

4. Type the range B5:B8 and press **Enter**.
 - vi. **Describe how formulas are used in Excel with examples.**
- Ans: Working with Formulas in Excel:**

A formula is an expression that performs calculations. It consists of operators, constants and cell addresses. The standard operators used in Excel formulas are given in Table.

Arithmetic operators used in Excel

Arithmetic Operation	Excel Operator
Addition	+
Subtraction	-
Multiplication	*
Division	/
Exponent	^

All the Excel formulas begin with equal sign (=) just like functions. For example, to multiply two numbers 4 and 7, the formula will be =4*7. User can also use cell addresses in formulas such as =(A4+B4)/5. This formula will first add the contents of cell A4 and B4 and then divide the sum by 5.

Examples:

Following are the steps to calculate the total number of laptop computer sale for the months of January, February and March in the worksheet shown in Fig.

1. Click cell B9 where the answer will appear.
2. Type the formula =B5+B6+B7+B8 as shown in Fig, and press Enter.

	A	B	C	D	E
1	MARGALLA COMPUTER SYSTEMS				
2	First Quarter Laptop Sales				
3					
4	Brand	January	February	March	
5	Acer	34	50	44	
6	Toshiba	23	15	28	
7	Dell	52	58	70	
8	HP	41	37	55	
9		=B5+B6+B7+B8			
10					

Using formula to find sum

3. To calculate the total number of laptop computers sold in the months of February and March copy the formula from cell B9 to C9 and D9.
4. Click the cell B9, point to the fill handle and drag it through cell D9.
The user can also calculate the total number of laptop computers sold in January by performing the following steps.
 1. Click cell B9.
 2. Click **Formulas** tab.
 3. Double-click the **AutoSum** command in the **Function Library** group.

Excel Automatically Recalculates Formula Results:

Whenever the user changes the value in a cell, the result of the formula in which that value is used will be automatically updated. This feature known as **automatic recalculation** is one of the main advantages that spreadsheets have over calculators.

Lab Activities

Activity 1:

Type the following text and apply the commands given at the end.

Computer Ethics:

Computer ethics is concerned with the moral guidelines for the ethical use of computer technology. It emerged with the invention of

computer. It specifies what is right and what is wrong when using computer technology. The following are some important points of computer ethics.

Computer should not be used to harm other people

Computer should not be used to commit any type of crime

Computer users should not create computer virus

- Center the title and make it bold
- Apply font size 16 to the title
- Justify the paragraph
- Underline and bold the words "Computer ethics" in the paragraph
- Apply italics and bold to the words "computer technology"
- Apply bullets to the last three lines

Activity 2:

Create weekly timetable of your class in Word and give title to it using WordArt.

Activity 1:

Activity 3:

Create the following worksheet in Excel and calculate sum and average using formulas.

Expenses of 1 st Quarter						
S.No.	Expense	Jan	Feb	Mar	Total	Average
1.	Salary	87000	102400	113800		
2.	Rent	2500	2500	2500		
3.	Utilities	3250	3500	3080		
4.	Transport	7830	6885	8940		
5.	Miscellaneous	4500	6708	7740		

Activity 4:

Create a column chart for expenses in the months of January, February and March for the above worksheet.

Activity 5:

Create the following worksheet in Excel and enter marks in the subject columns in the range 0 to 75. Restrict data entries in the subject columns to the specified range using data validation command.

S.No.	Student Name	Mathematics	Physics	Computer	Chemistry
1.	Abrar Nabi				
2.	Mumtaz Akbar				
3.	Muhammad Bilal				
4.	Javed Akhtar				
5.	Afzal				
6.	Muslim Khan				

Activity 6:

Write a leave application in Urdu using the Inpage Urdu editor

CHAPTER 4

DATA COMMUNICATION

SHORT AND LONG QUESTIONS

Q.1 Define data communication.

Ans: Data Communication:

Data communication is the transmission of data between two points. A data communication system is a collection of hardware and software arranged to communicate information from one location to another.

Q.2 Define data, data transmission, analog signals and digital signals

Ans: Basic Terms of Data Communication:

The following terms are associated with data communication.

- Data
- Data transmission
- Analog signal
- Digital signal

Data:

Data means any types of raw facts and figures which can be provided as input to the computer for processing. Data can be in the form of text, sound, graphics, image or video.

Data transmission:

Data transmission means sending information from one place to other using computer networks and data communication systems. In computer technology, it means sending streams of bits or bytes from one place to another using copper wire, Fibre optics, satellite communication, etc.

Analog and Digital Signals:

A signal is a variation of physical quantity with time. The physical quantity can be temperature, pressure, rate of heart beat, etc. An electrical signal is a change in voltage or current with time.

Electrical signals can be divided into two main types, analog and digital signals.

Analog signals are continuous. They vary continuously within a range. Analog transmission uses signals that are exactly the same as sound waves.

- Digital signals consist of binary digit 0 and 1 to represent information. These signals are transmitted by a series of "ON" and "OFF" signals by pulses of electricity or light. The "ON" signal represents binary 1 and "OFF" signal binary 0.

Q.3 Define transmission media.

Ans: Transmission Media:

Transmission media provide the means by which data travels from source to destination. In other words, it is the pathway for transmitting data.

Q.4 Describe types of transmission media.

Ans: Types of Transmission Media:

There are two types of transmission media, Guided Media and Unguided Media

Guided Media:

Guided media uses cabling system that guides the data signals along a specific path. Different types of guided media are twisted pair, coaxial cable and Fibre optic cable.

Unguided Media:

Unguided media signals travel through open space and nothing guides them along any specific path.

Point To Ponder

Why do satellites stay in orbit and never fall on the earth?

Ans: This is the law of inertia. The force of gravity acts upon a high speed satellite to deviate its trajectory from a straight-line inertial path. Indeed, a satellite is accelerating towards the Earth due to the force of gravity. Finally, a satellite does fall towards the Earth; only it never falls into the Earth.

Q.5 Define amplification.

Ans: Amplification:

Amplification refers to strengthening of signal to solve the problem of attenuation in data transmission.

Amplifier:

An **amplifier** is a device used in data communication that receives weak signals, amplifies it and then retransmits.

Q.6 List the communication devices.

Ans: Communication Devices:

A communication device is hardware that is used for transmission of information from one place to another between computers and other devices.

The following communication devices are commonly used in computer networks in data communication systems.

- Dial-up Modem
- Router
- Network Interface Card
- Switch/Access Point

For Your Information

The first dial-up modem was built in 1962. It had a speed of 300 bits per second.

Do You Know?

Wireless network card provides an easy way to create a wireless network but it is slow and less reliable than wired network card.

Q.7 List the data transmission terminologies.

Ans: Communication Terminologies:

Communication Terminologies refers to terms or words that are related with data transmission or characteristics of communication channel.

Data Transmission Terminologies:

The following terms are used to determine the data transmission capabilities of a transmission media such as telephone line, coaxial cable, etc.

- Data rate
- Bandwidth
- Baud rate
- Signal to Noise Ratio

Q.8 Describe Signal-to-Noise Ratio.

Ans: Signal-to-Noise Ratio:

Signal-to-noise ratio is the ratio of signal power to the noise power that causes errors in data transmission. In other words, it means the ratio of useful data transmission to errors caused by noise over a transmission medium.

The measurement of Signal-to-noise ratio defines the data transmission quality of a communication medium.

If a transmission line has Signal-to-noise ratio higher than 1:1 that means more signal transmission than noise.

Q.9 Use appropriate formulae to determine the characteristics of a communication channel

OR

Describe the Characteristics of Communication Channel.

Ans: Characteristics of Communication Channel:

The maximum number of bits that can be transmitted over a communication line is a characteristic of transmission media. If more bits per second are transmitted than the line is capable of, some information will be lost due to transmission errors.

The baud rate can be calculated as:

Baud rate = Number of signal changes per second

The baud rate and data transmission rate measured as bits per seconds are not always the same.

For example, the Baud rate of a transmission line that uses modem is 28 kbps. If the electrical signal has two states to represent binary digits 0 and 1, then the Baud rate and data rate are the same.

If the electrical signal has four states to represent 00, 01, 10 and 11 as mentioned earlier, then Baud rate and data rate will not be the same.

Data rate will be calculated as:

Data rate = 2 × Baud rate = 2 × 28 = 56 kbps

KEY POINTS

- Data communication refers to transmission of information from one location to another using copper wires, Fibre optics, satellites, etc.
- A data communication system is a collection of hardware and software arranged to communicate information from one location to another.
- Analog signals are continuous. They vary continuously within a range. Analog transmission uses signals that are exactly the same as sound waves.
- Digital signals consist of binary digit 0 and 1 to represent information. These signals are transmitted by a series of "ON" and "OFF" signals by pulses of

electricity or light. The "ON" signal represents binary 1 and "OFF" signal binary 0.

- Transmission medium is the physical pathway over which message is transmitted from sender to receiver.
- Protocol is a set of rules between two communication devices that govern the process of data communication.
- In asynchronous transmission, time interval between each character is not the same. Each character is transmitted with additional start and stop bits.
- In synchronous transmission, time interval between each character is always the same. It does not require start or stop bits.
- Guided media uses cabling system that guides the data signals along a specific path.
- Unguided media signals travel through open space and nothing guides them along any specific path.
- Radio waves are electromagnetic waves that are propagated by antennas
- Satellite is an object that is placed in an orbit around the earth and revolves around it with speed that is same as the rotational speed of earth for communication.
- Attenuation is signal fall off with distance in guided or unguided media.
- Distortion refers to signal change in shape or form as it travels through communication lines.
- Cross talk refers to undesired signals that enter the path of the transmitted signal due to electromagnetic radiation.
- A Network Interface Card (NIC) is used to connect computers together to create computer network and make communication between computers possible.
- A router is a communication device used to connect computers together in different networks.
- A switch is used for connecting computers together in wired local area network whereas access point connects computers in wireless local area network.

EXERCISE

- Q1. Select the best answer for the following MCQs.**
- In which type of data transmission start/stop bits are used?**
A. Synchronous transmission B. Asynchronous transmission
C. Satellite transmission D. Microwave transmission
 - In which of the following transmission, the time interval between the characters is always the same?**
A. Synchronous transmission B. Asynchronous transmission
C. Satellite transmission D. Microwave transmission
 - Which of the following transmission media uses light waves for transmitting information?**
A. Coaxial cable B. Twisted pair cable

electricity or light. The "ON" signal represents binary 1 and "OFF" signal binary 0.

- Transmission medium is the physical pathway over which message is transmitted from sender to receiver.
- Protocol is a set of rules between two communication devices that govern the process of data communication.
- In asynchronous transmission, time interval between each character is not the same. Each character is transmitted with additional start and stop bits.
- In synchronous transmission, time interval between each character is always the same. It does not require start or stop bits.
- Guided media uses cabling system that guides the data signals along a specific path.
- Unguided media signals travel through open space and nothing guides them along any specific path.
- Radio waves are electromagnetic waves that are propagated by antennas
- Satellite is an object that is placed in an orbit around the earth and revolves around it with speed that is same as the rotational speed of earth for communication.
- Attenuation is signal fall off with distance in guided or unguided media.
- Distortion refers to signal change in shape or form as it travels through communication lines.
- Cross talk refers to undesired signals that enter the path of the transmitted signal due to electromagnetic radiation.
- A Network Interface Card (NIC) is used to connect computers together to create computer network and make communication between computers possible.
- A router is a communication device used to connect computers together in different networks.
- A switch is used for connecting computers together in wired local area network whereas access point connects computers in wireless local area network.

EXERCISE

Q1. Select the best answer for the following MCQs.

- In which type of data transmission start/stop bits are used?**
A. Synchronous transmission B. Asynchronous transmission
C. Satellite transmission D. Microwave transmission
- In which of the following transmission, the time interval between the characters is always the same?**
A. Synchronous transmission B. Asynchronous transmission
C. Satellite transmission D. Microwave transmission
- Which of the following transmission media uses light waves for transmitting information?**
A. Coaxial cable B. Twisted pair cable

- C. Telephone line D. Fibre optic cable
- iv. Which of the following is used for short distance communication?**
A. Radio signals B. Microwave
C. Infra-red D. Satellite communication
- v. In which of the following impairment, the strength of signal falls off with distance?**
A. Distortion B. Attenuation
C. Cross talk D. Noise
- vi. Which of the following impairment refers to undesired signals that enter the path of the transmitted signal due to electromagnetic radiation?**
A. Distortion B. Attenuation
C. Cross talk D. Noise
- vii. Which of the following device is used for connecting computers together in wireless local area network?**
A. Dial-up modem B. Router
C. Switch D. Access point
- viii. Which of the following device is used for connecting computers together in wired local area network?**
A. Dial-up modem B. Router
C. Switch D. Access point
- ix. Which of the following device forwards information from one network to another by selecting the best pathway available?**
A. Dial-up modem B. Router
C. Switch D. Access point
- x. What represents the overall data transmission capacity of a computer network?**
A. Data rate B. Bandwidth
C. Signal strength D. Baud rate

Answers

i. B	ii. A	iii. D	iv. C	v. B
vi. C	vii. D	viii. C	ix. B	x. B

Q2. Write short answers of the following questions.

i. Differentiate between analog and digital signals.

Ans: Difference between analog and digital signals:

Analog signals:

Analog signal is in continuous form. It varies continuously within a range as shown in Fig (a). For example, sound is an analog signal. Analog transmission uses signals that are exactly the same as sound waves.

Digital signals:

Digital signals are not continuous. They switch between two discrete, low and high voltage levels as shown in Fig (b). In digital computers, low voltage level represents binary 0 and high voltage level represents binary 1. Information represented in digital form can be easily transmitted by series of "ON" and "OFF" signals by pulses of electricity. A pulse "ON" can represent 1 and the absence of pulse "OFF" can represent 0.

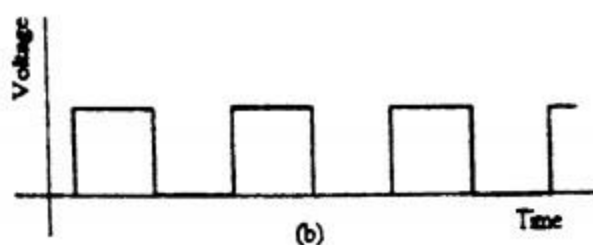
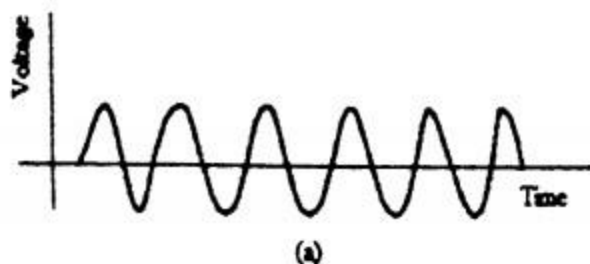

(a) Analog and (b) Digital Signals

OR (Second Answer)

Difference between analog and digital signals:

	Analog signal	Digital signal
Basic	An analog signal is a continuous wave that changes over a time period.	A digital signal is a discrete wave that carries information in binary form.
Representation	An analog signal is represented by a sine wave.	A digital signal is represented by square waves.
Description	An analog signal is described by the amplitude, period or frequency, and phase.	A digital signal is described by bit rate and bit intervals.
Range	Analog signal has no fixed range.	Digital signal has a finite range i.e. between 0 and 1.
Distortion	An analog signal is more prone to distortion.	A digital signal is less prone to distortion.
Transmit	An analog signal transmit data in the form of a wave.	A digital signal carries data in the binary form i.e. 0 and 1.
Example	The human voice is the best example of an analog signal.	Signals used for transmission in a computer are the digital signal.

ii. Why digital signals are used in computer systems?

Ans: Information represented in digital form can be easily transmitted by series of "ON" and "OFF" signals by pulses of electricity. A pulse "ON" can represent 1 and the absence of pulse "OFF" can represent 0.

Multiple bit (0,1) streams are used in a computer network. Digital data can be compressed relatively easily, thereby increasing the efficiency of transmission.

That is why digital signals are used in computer systems.

iii. Name the properties of a good communication system.

Ans: Characteristics of a Good Communication System:

Following are the properties of a good communication system.

Delivery:

Data communication system must deliver the message to the correct destination. Message must be received by only the device or user to whom it is sent.

For example, when e-mail is sent to a person, it is received only by the person to whom it is addressed. This is managed by the protocol used in the data communication system.

Accuracy:

System must deliver the message accurately without any change. If incorrect data is transmitted by the system, it may not be usable by the receiver.

For example, when data is transmitted over a long distance, it may get corrupted due to transmission errors. The data that is not correctly received at the destination is retransmitted from the source. This is ensured by the protocol used in the data communication system.

Timeliness:

The system must deliver the data without significant delay in a timely manner. It is very important in real time transmission such as video conferencing that video and audio are delivered as soon as they are produced. Data delivered late may be useless.

Some real time systems require immediate transmission of data within limited time.

For example, a computerized real time system is used to monitor the temperature in an oil refinery. If the temperature is getting too high, it must be transmitted immediately otherwise there can be an explosion.

iv. Give any three reasons why guided communication medium is more reliable than unguided medium.

Ans: The purpose of Guided media is to reduce cross talk and electromagnetic interference and make the transmission more reliable.

It provides high quality transmission at extremely fast speed. It can transmit trillions of bits per second.

Guided media is not affected by electromagnetic fields and can transmit both analog and digital signals.

Guided media is used for data transmission over long distance.

Unguided Media has multipath interference, due to reflections from land, water, natural and human-made objects.

That is why guided communication medium is more reliable than unguided medium.

v. What is meant by transmission impairment?

Ans: Transmission Impairments:

The errors that occur during data communication from one point to another are called transmission impairments.

When a signal is transmitted over a communication medium, it may have different types of impairments. Impairments occur due to imperfect characteristics of communication medium. As a consequence, the received and the transmitted signals are not always the same.

Types of impairments:

The types of impairments in communication media are:

- | | |
|-----------------|-------------------|
| i. Attenuation | ii. Amplification |
| iii. Distortion | iv. Cross talk |

vi. Differentiate between attenuation and distortion.

Ans: Attenuation:

Attenuation is the fall of signal strength with the distance as signal travels through the communication media. If the attenuation is too much, the receiver may not be able to detect the signal at all.

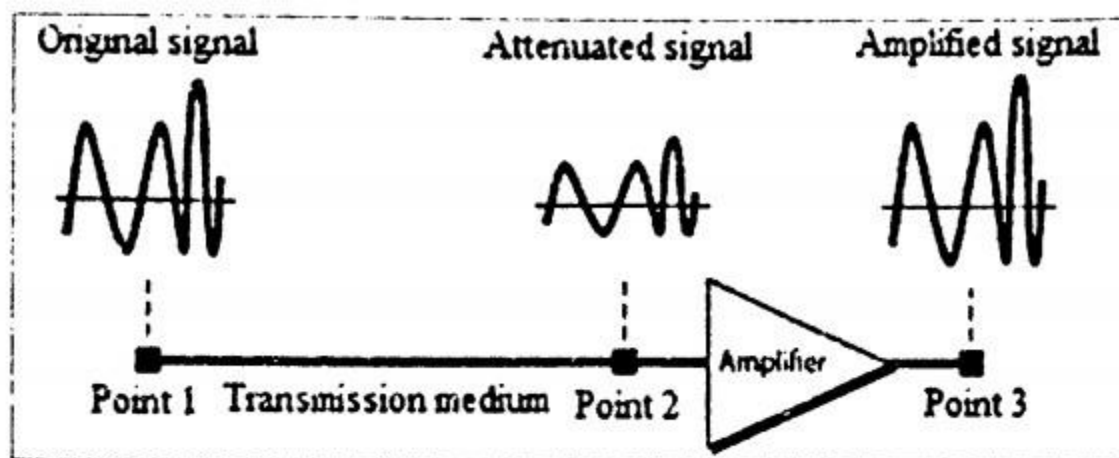

Attenuation in data communication

Distortion:

Distortion refers to change in shape or frequency of digital signal when it is transmitted over a communication line. Fig (a), shows the transmitted signal and Fig (b), shows the distorted received signal.

Communication line delays the signal frequency by different amounts because different frequency components travel at different speed. Therefore, various frequency components of a signal are received at different delays. This causes distortion in digital signals.



Distortion in digital signal

vii. What is cross talk?

Ans: Cross Talk:

Cross talk occurs in guided media. As signal is transmitted through a wire, undesired signals enter the path of the transmitted signal due to electromagnetic radiation. It is caused because of putting several wires together in a single cable.

Sometimes, user can hear another conversation in the background when talking on the phone. This happens by the coupling between two wires that are close to each other.

viii. What is Dial-up modem? Why is it used?

Ans: Dial-up Modem:

Dial-up modem, provides Internet connection through telephone line. Maximum speed of Dial-up modem is 56 Kilobits per second which is very slow. It is being replaced by faster DSL connection for Internet. A Dial-up modem is shown in Fig.

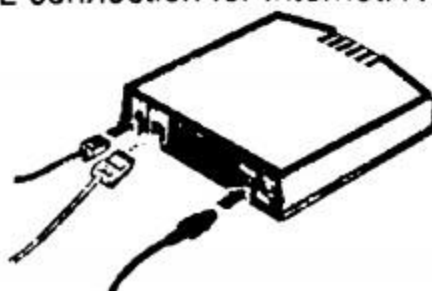

Dial - up modem

Uses of Dial-up Modem:

A telephone line is used for voice transmission which is analog signal. A modem converts digital computer signal to analog form for transmission over telephone line as shown in Fig. This process is called modulation.

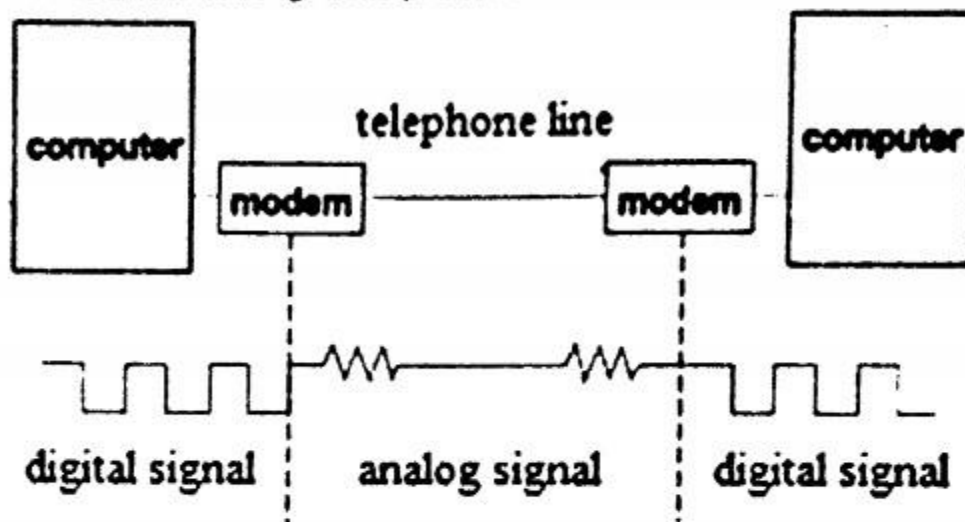

Transmission of data using modem

Another, modem at the receiving end, converts the analog signal back to digital form which is called demodulation.

Modem is abbreviation of **Modulator-Demodulator**.

ix. Define data rate and baud rate.

Ans: Data Rate:

Data rate is the speed with which data can be transmitted from one device to another. It is generally measured in Kilobits (thousand bits) or Megabits (million bits) per second.

Note: The abbreviation kbps, is used for kilobits per second and mbps for million bits per second.

Baud Rate:

Baud is the rate of change of electrical signals per second during data communications. An electrical signal can have two or more than two states to represent binary digits 0 and 1.

If an electrical signal has two states to represent binary digits then one state represents binary 0 and the other binary 1. In this case the baud rate and the number of bits transferred per second (data rate) are the same.

If an electrical signal has four states then each state can represent two binary digits.

For example, the analog signals generated by modem can have four voltage levels such as 1, 2, 3 and 4 Volts. There are four states of analog signal one for each voltage level. These four voltage levels can be used to represent 00, 01, 10 and 11. These will double the bit transfer rate.

x. Define bandwidth.

Ans: Bandwidth:

Bandwidth describes the overall data transmission capacity of a medium or channel. It represents the amount of data that passes through a network connection per unit of time.

Bandwidth is also measured in bits per second like data rate.

Q3. Write long answers of the following questions.

i. Describe the components of communication system with the help of diagram.

Ans: Components of a Communication System:

Communication system consists of the following five basic components as shown in Fig.

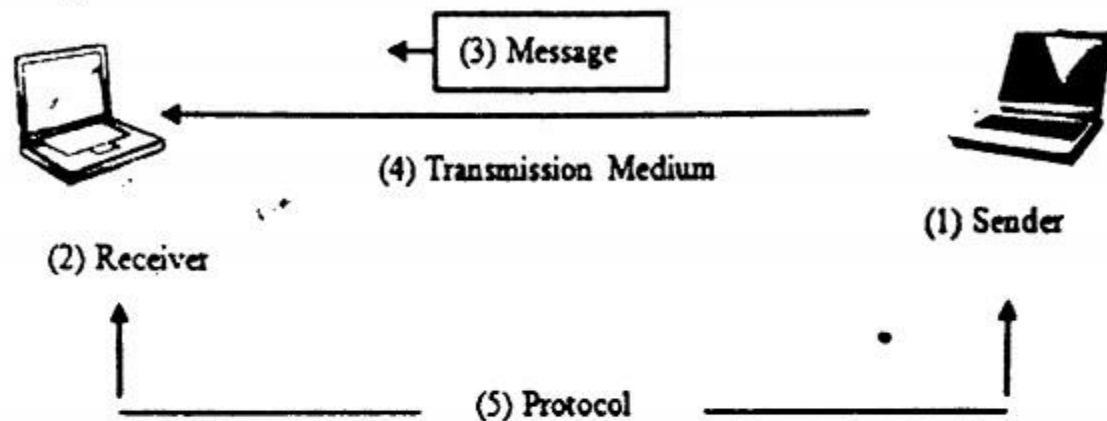

Components of a communication system

- **Sender**
- **Message**
- **Protocol**
- **Receiver**
- **Transmission Medium**

Sender:

It is the device which sends the message. In other words, it is the source of message that can be a computer, telephone handset, etc.

Receiver:

It is the device which receives the message. In other words it is the destination of message that can be a computer, radio, telephone handset, etc.

Message:

It is the data to be transmitted. It can be text, graphics, image, sound or video.

Transmission Medium:

It is the physical pathway (also known as channel) over which the message is sent from sender to receiver. Some examples of transmission media are coaxial cable, Fibre optic cable, microwaves, etc.

Protocol:

It is the set of rules between the two communicating devices that governs the process of data communication. Without a protocol, two devices may be connected but they cannot communicate with each other.

ii. Explain asynchronous and synchronous transmission modes with examples.

Ans: Asynchronous and Synchronous Transmission modes:

Asynchronous and synchronous transmissions are the methods by which characters are transferred between components within the computer or between the computer and an external network.

Asynchronous Transmission:

The transmission mode in which time interval between each character is not the same is known as asynchronous transmission. This is shown in Fig.

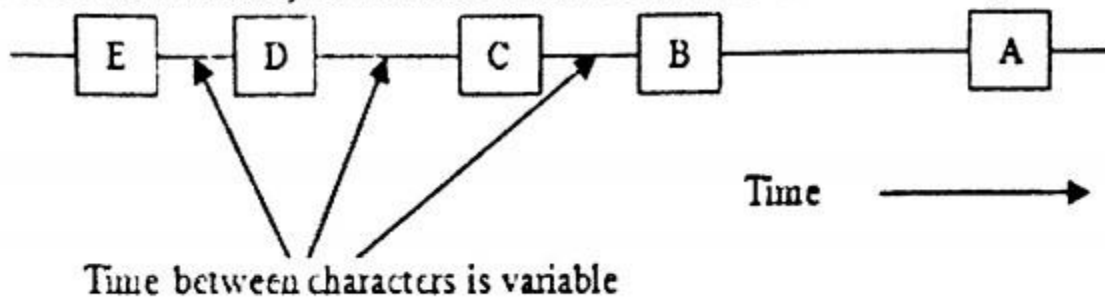

Asynchronous transmission

- In asynchronous transmission, each character is transmitted with additional control information. Control information consists of additional start and stop bits. Start bit indicates that transmission is about to start and stop bit indicates that it is about to stop.
- Start bit is generally 0 and stop bit is 1.
- Between the start and stop bits, the bits representing a character are transmitted at uniform time intervals.
- Asynchronous transmission is slow because of the additional bits transmitted with each character. It is suitable for low speed connection between system unit and keyboard or mouse.

Synchronous Transmission:

The transmission mode, in which time interval between the characters is always the same, is known as synchronous transmission. This is shown in Fig.

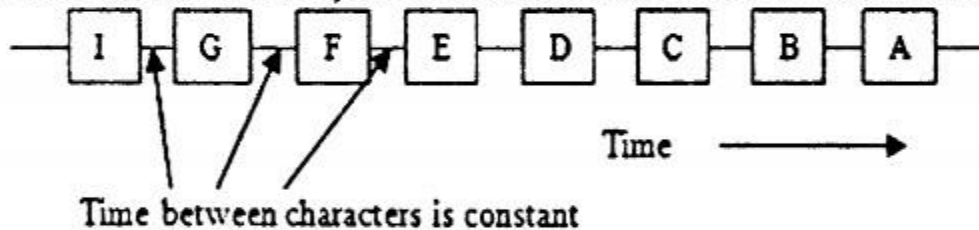

Synchronous transmission

- In synchronous transmission, there is no control information added with the characters.
- Data consisting of 0s and 1s is transmitted as one long stream of bits. The receiver counts the bits as they arrive and recognizes the characters.
- Synchronous transmission is faster than asynchronous transmission because it does not require extra start and stop bits. Therefore, it is used for fast data communication between computers in computer networks.

iii. Describe the following guided media.

- a) Twisted pair cable
- b) Coaxial cable
- c) Fiber optic cable

Ans: a) Twisted pair cable:

Twisted pair cable is the most commonly used cable for data communication. It consists of pairs of copper wires twisted around one another as shown in Fig.



Twisted pair cable

Purpose of twisting the cables:

The purpose of twisting the cables is to reduce cross talk and electromagnetic interference and make the transmission more reliable.

Telephone cable consists of two twisted insulated wires.

Computer network cable consists of 4 pairs of twisted cables.

Transmission speed of twisted pair cable:

Transmission speed of twisted pair cable ranges from 2 million bits per second to 10 billion bits per second.

b) Coaxial cable:

Coaxial cable is used for local area networks and cable television systems. It consists of copper wire surrounded by insulating layer.

The insulating layer itself is surrounded by conductive layer as shown in Fig.

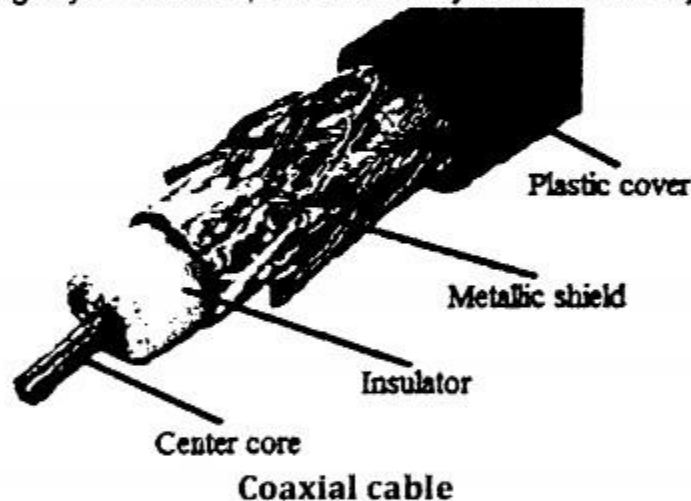

Purpose of Insulation:

Insulation reduces interference and distortion.

Transmission speed Coaxial Cable:

Transmission speed ranges from 200 million bits per second to more than 500 million bits per second.

c) Fiber optic cable:

Fibre optic cable consists of smooth hair-thin strands of transparent material. In Fibre optic communication, the transmitter has a converter that converts electrical signals into light waves. These light waves are transmitted over the Fibre optic cable. Another converter is placed at the receiving end that converts the light waves back to electrical signals.

Capacity of single Fibre optic cable:

A single Fibre optic cable can carry up to 50,000 communication lines. It provides high quality transmission at extremely fast speed. It can transmit trillions of bits per second.

It is not affected by electromagnetic fields and can transmit both analog and digital signals.

Note: Fiber optic cable is more expensive than twisted pair and coaxial cables. It is used for data transmission over long distance. Fibre optic cable is shown in Fig.

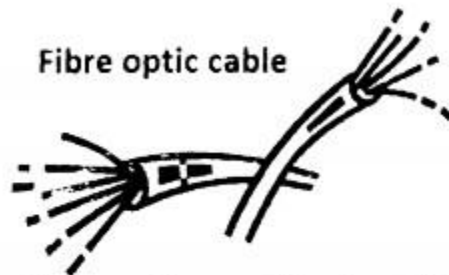

iv. Describe any three types of unguided media.

Ans: Unguided Media:

Unguided media signals travel through open space and nothing guides them along any specific path. They do not use cables for data transmission.

Types of unguided media:

Unguided media can be classified into radio waves, microwave, infra-red and satellite communication.

Radio Waves:

Radio waves are electromagnetic waves that are propagated by antennas. Radio transmission consists of a transmitter and a receiver.

A transmitter transmits a radio signal to a receiver which receives it. Radio waves are used to transmit music, conversation, pictures and data. Data can be transmitted over long distance using radio waves. These waves are invisible and undetectable to human beings.

The following are some applications of radio waves.

- Radio and television broadcast as shown in Fig.

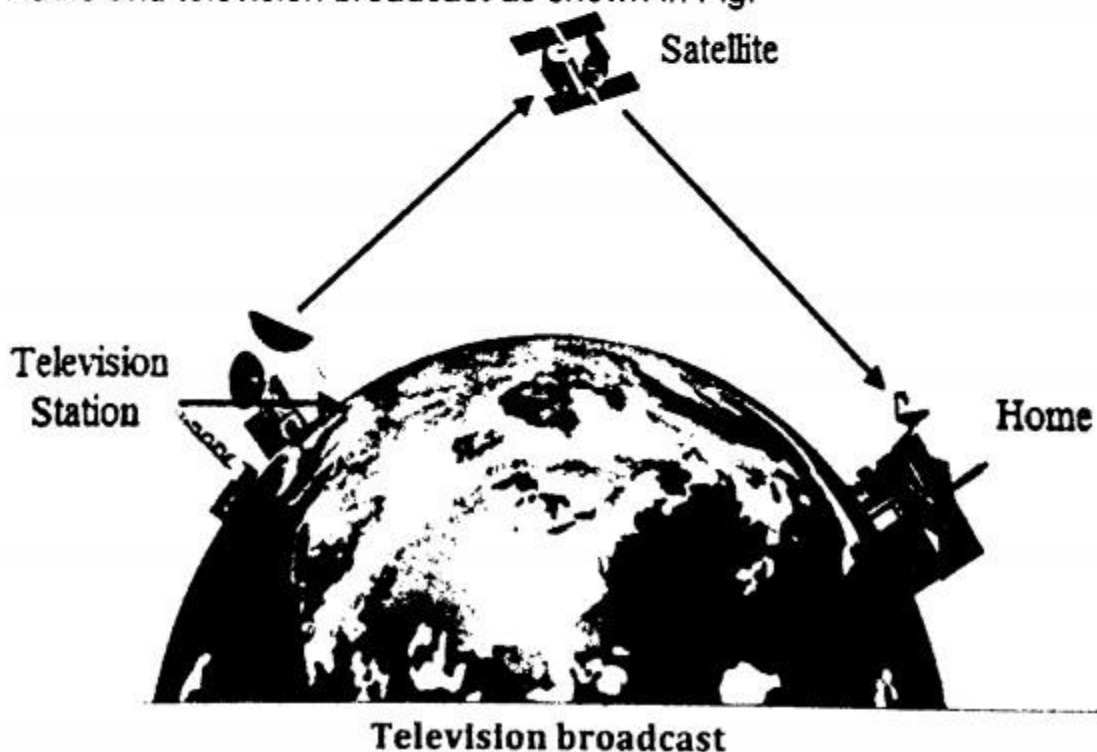

- Cell phones communication as shown in Fig.

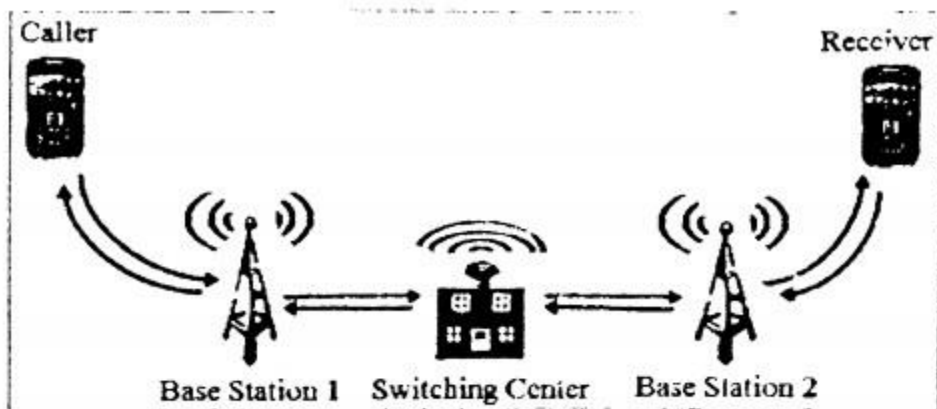

Cell phone communication

- Radio-controlled toys as shown in Fig.



Radio controlled car

- Satellite communication
- Wireless networks and wireless Internet

Microwave:

Microwave signals travel through open space like radio waves. Microwaves provide much faster transmission rate than telephone lines or coaxial cables.

Microwave antennas are installed on high buildings or high towers as shown in Fig. The transmitting and the receiving sites must be within sight of one another. Microwaves are used for satellite communication and other long distance wireless communications.

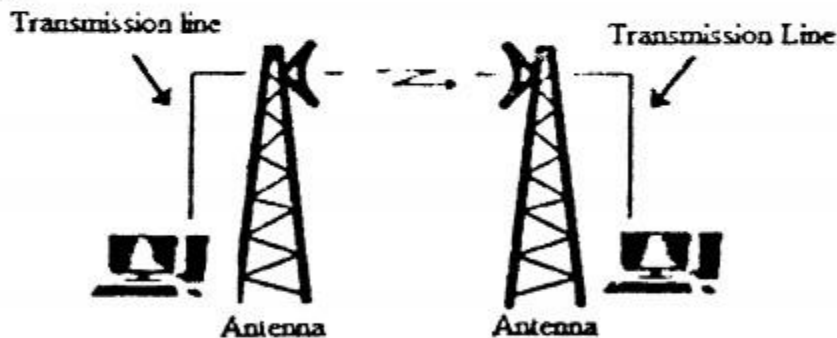

Microwave Transmission

Infra-red:

Infra-red waves are light energy that we cannot see. It travels through space at the speed of light. It is used for short distance communication.

Infra-red waves are usually used in remote controls for television, DVD players and other similar devices. Infra-red wireless signals are disrupted by persons or objects in between the transmitter and receiver but it does not get interference of other radio signals.

It is also used in industrial, scientific and medical appliances and night-vision devices. Infra-red communication between television and remote control is shown in Fig.



Infra – red communication

Bluetooth:

Bluetooth is a wireless communication technology that uses radio waves to connect portable electronic devices over short distance. It eliminates the need for cable connection and provides fast and reliable transmission.

It supports networking of wide range of portable devices that work on low battery. These devices include mobile phone, mouse, keyboard, wireless speaker, wireless headset, tablet, laptop computer and personal computer.

Laptop computer has built-in Bluetooth but personal computer can use Bluetooth adapter to communicate with Bluetooth devices.

The most common use of Bluetooth is connecting a mobile phone to a wireless headset or to a laptop computer to transfer voice data. Bluetooth technology can transmit text, image, voice and video.

Satellite:

A satellite is an object that is placed in an orbit around the earth and revolves around it with speed that is slightly faster than Earth's average orbital speed for communication.

It is a wireless Receiver and Transmitter used for transmitting data over long distance at high speed. Ground stations beam signals through antennas to satellites. Satellites amplify and retransmit the signals to another ground station which can be located many thousands of miles away as shown in Fig.

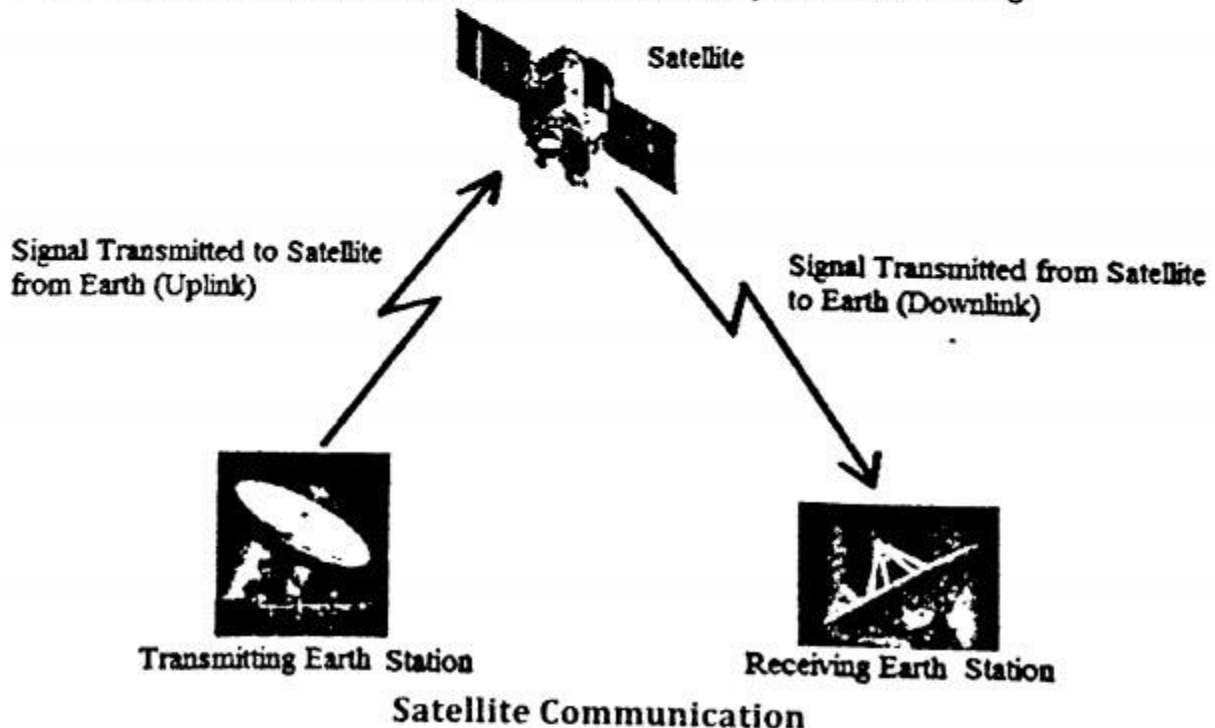

Drawback of satellite communication:

The main drawback of satellite communication is the high cost of placing the satellite into its orbit. Satellites are launched by rockets or space shuttles and precisely positioned in the space with an orbit speed that exactly matches with the rotation speed of the earth.

v. Describe the functions of the following communication devices.

a) Router

b) Network Interface Card (NIC)

c) Switch/Access point

Ans: a) Router:

Router is a communication device that is used when two networks have to be connected for communication. They send information from one network to another by selecting the best pathway available.

Types of routers:

There are two types of routers i.e. wired and wireless.

A wireless router is shown in Fig. This router is used to connect wireless devices such as laptop computer and mobile phone to Internet.



b) Network Interface Card (NIC):

A Network Interface Card (NIC) or simply network card is used to connect computers together to create computer network. It makes communication between computers possible.

It is a card that is installed on the motherboard. In modern computers, it is integrated on the motherboard.

Types of network cards:

There are two types of network cards, wired network card and wireless network card. Wired and wireless network cards are shown in Fig.

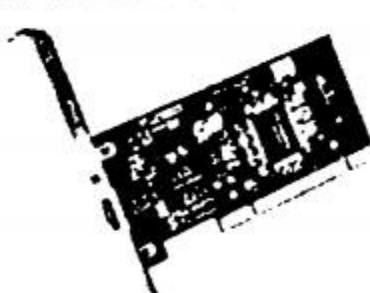

(a) Wired Network Card

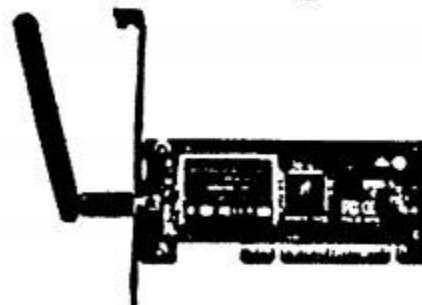

(b) Wireless Network Card

Network cards

c) Switch/Access Point:

A switch/access point is used for connecting computers together in local area network (LAN). Switch is used in wired networks whereas access point is used in wireless networks.

A switch/access point receives information from a computer in the network, inspects it and then transmits it appropriately to the destination computer. A switch and an access point are shown in Fig.

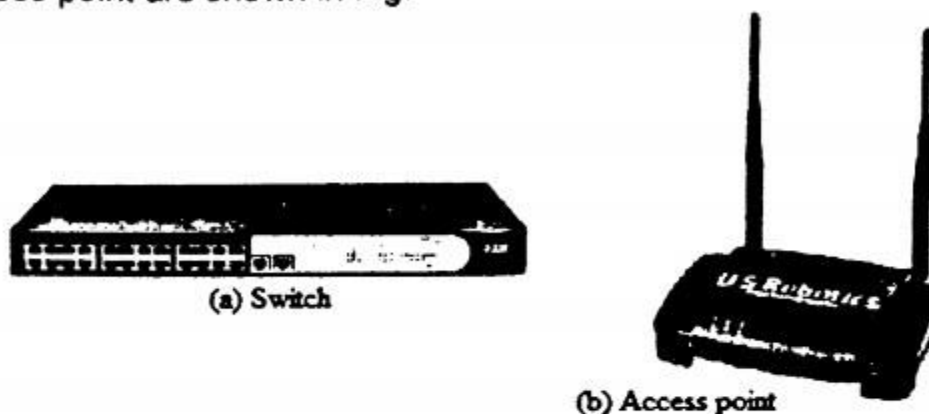

Switch and access point

Lab Activities

Activity 1:

Students should be shown twisted pair, coaxial and fibre optic cables and their usage in data communication.

Activity 2:

Students should be shown communication devices such as network card, router, switch, etc.

CHAPTER 5

COMPUTER NETWORKS

SHORT AND LONG QUESTIONS

Q.1 What is meant by computer network?

Ans: **Computer Network:**

A computer network can be defined as an interconnection of two or more computers to share data and other resources such as documents, printers and Internet connection. A small computer network is shown in Fig.

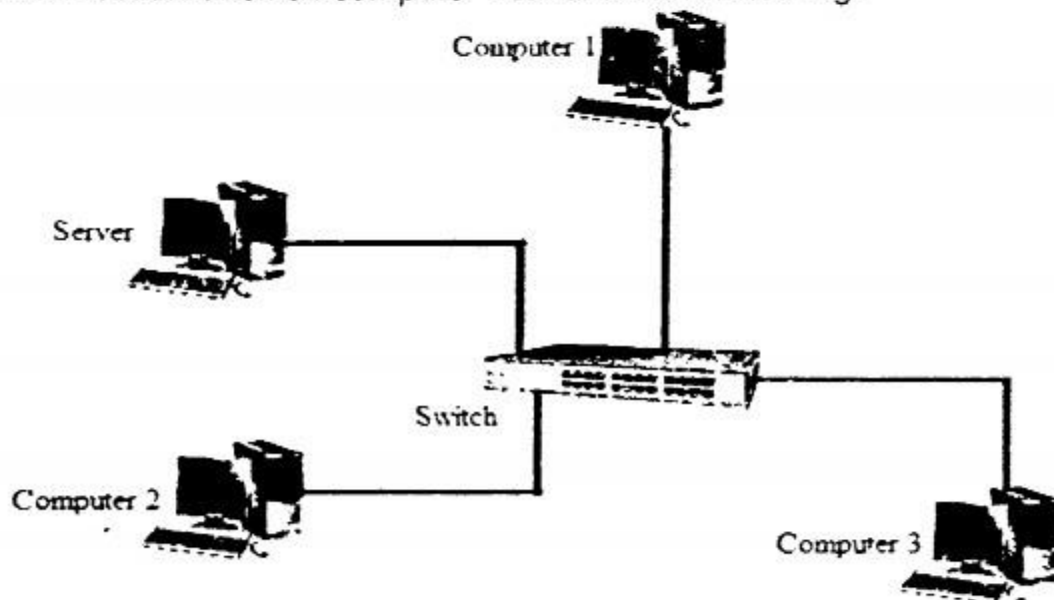

A Small Computer Network

For Your Information

Internet is a world-wide network that interconnects millions of computers and provides information and communication facilities.

Q.2 Define data transmission.

Ans: **Data Transmission:**

Data transmission is the process of sending data from one device to another. It consists of sender, receiver and the medium which carries the information.

Q.3 List three modes of data transmission.

Ans: There are three modes of data transmission which are simplex, Half-duplex and Full-duplex.

Q.4 Write a note on simplex transmission mode.

Ans: **Simplex Transmission Mode:**

A simplex mode provides data transmission in only one direction. One end is the sender and the other is receiver as shown in Fig.

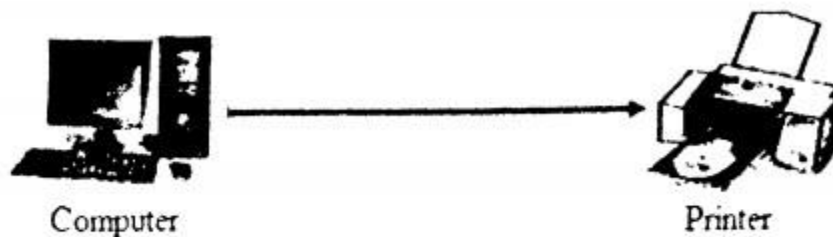

Transmission through simplex mode

Transmission of data/information from keyboard to CPU or from CPU to printer is always in one direction. Therefore, these are simplex transmissions. Radio and television broadcastings are also simplex transmissions.

Q.5 What is meant by network architecture?

Ans: Network Architecture:

Network architecture refers to layout of network that consists of computers, communication devices, software, wired or wireless transmission of data and connectivity between components.

A computer network can be as small as two computers linked together by a single cable whereas large networks connect thousands of computers and other devices.

Q.6 List three types of network architecture.

Ans: Types of Network Architectures:

Three types of network architectures are commonly used which are:

- i. Client/server network
- ii. Peer-to-peer network
- iii. Point-to-point network

Q.7 Write a note on Point-to-Point networks.

Ans: Point-to-Point Networks:

It is a type of network in which a message is sent from one computer to another via other computers in the network. Large networks such as wide area networks that connect cities and countries are organized in such a way. Point-to-Point network is shown in Fig.

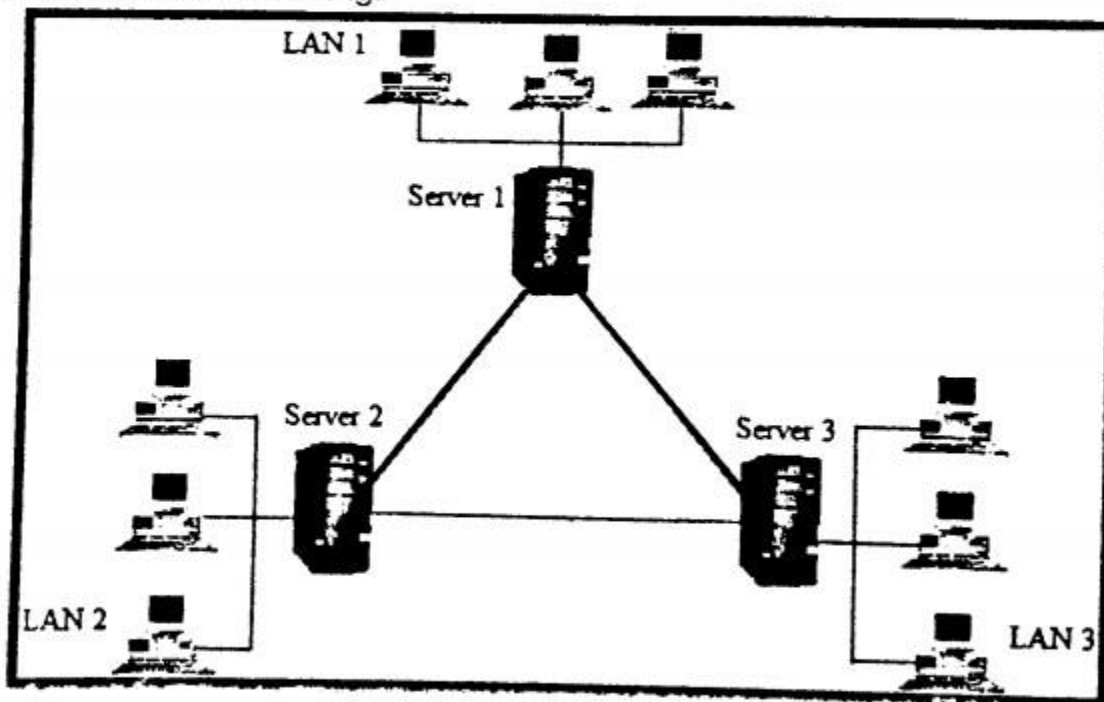

A Point – to – Point Network

Characteristics of Point-to-Point Networks:

- i) Point-to-Point networks are generally used for long distance communication.
- ii) There may be different paths for transmission of information.

Q.8 What is meant by communication over network?

Ans: Communication over Networks:

Communication over network refers to transmission of data/information from one computer to another through a communication medium.

Q.9 Write a note on communication via telephone networks.

Ans: Communication via Telephone Networks:

Telephone network is now commonly used for data communications. The main reason for using telephone network is that it exists all over the world.

Types of communication lines are provided via telephone networks:

Following four types of communication lines are provided via telephone networks.

- Dial-up line
- Digital Subscriber Line (DSL)
- Integrated Services Digital Network (ISDN) lines
- Code Division Multiple Access (CDMA)

Q.10 Explain different types of modem which are commonly used.

Ans: Types of Modems:

There are three types of modem which are commonly used. These are Dial-up modem, DSL modem and ISDN modem.

Dial-up Modem:

A Dial-up modem is required for Dial-up Internet connection. It is the short form of **MODulator/DEModulator**.

Modem accepts digital data from the computer in the form of two-level signals and converts them into analog signals for transmission over the telephone line. This process is called modulation. A second modem at the receiving end is used to convert the analog signals back to digital form which is called demodulation. Dial-up modems are shown in Fig.

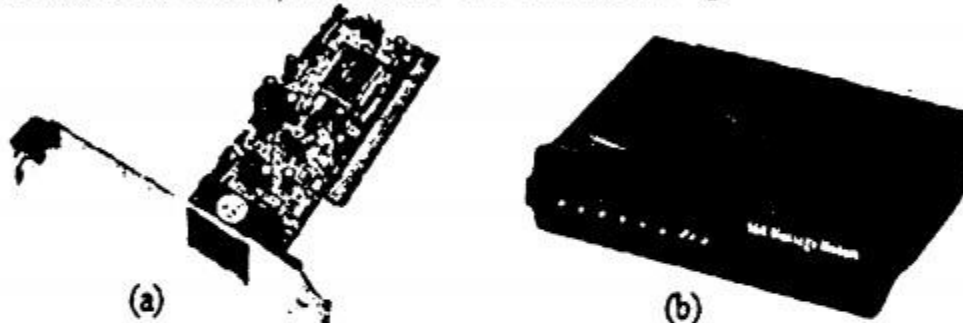

(a) Internal Dial – up modem (b) External Dial – up modem

DSL Modem:

A DSL modem is used to connect microcomputers to high-speed DSL connections. It is designed to provide high-speed Internet access.

ADSL modem is an external device that connects to a computer via USB or Ethernet port. These ports are usually available at the back of system unit. Wireless DSL modems are also available for connecting laptop and other wireless devices such as mobile phones to Internet.

DSL modem converts the digital signals into analog high frequency signals that are carried by the telephone lines and vice versa. DSL modems are shown in Fig.

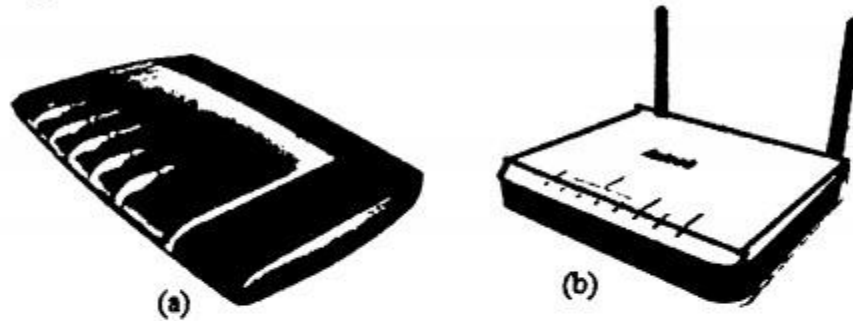

(a) Wired DSL Modem (b) Wireless DSL Modem

ISDN Modem:

ISDN modem is a device that converts digital signals used in computers to the signals that can be transmitted over the ISDN lines. It provides both voice and data transmission on a single line at the same time. ISDN modem is shown in Fig.



ISDN Modem

Q.11 Compare data communication lines on the basis of transfer rate, cost per month, advantages and disadvantages.

Ans: Comparison between Data Communication Lines:

Dial-up Line:

- Maximum speed is 56 Kbps.
- Easily available anywhere, no extra lines required.
- Cheaper than other Internet services.
- Internet connection is not permanently available.
- Voice communication is not possible while using Internet.

DSL (Digital Subscriber Line):

- Typical speed is 256Kbps or above.
- DSL connection is always available.
- Telephonic conversation and Internet access are available simultaneously.
- Costly than other types of Internet services.
- Various monthly rates are charged depending on the speed.
- Connection is available as soon as computer and DSL modem are turned on.

ISDN (Integrated Services Digital Network):

- Maximum communication speed is 128 Kbps.
- Costs more than Dial-up service.
- Can simultaneously transmit both voice and data.

- Allows multiple devices to share a single line.

CDMA (Code Division Multiple Access):

- It is a wireless cellular communication technology.
- Transmission speed can be up to a several Mbps.
- Can provide service to many people at the same time.
- Provides improved voice quality.

KEY POINTS

- A computer network is an interconnection between computers and devices to provide facilities among users to exchange information and resources such as printer, hard disk, Internet, etc.
- Simplex transmission mode provides data transmission in only one direction.
- Half-duplex transmission mode can send and receive data in both directions but not simultaneously.
- Full-duplex transmission mode provides data transmission in both directions at the same time.
- A computer that shares resources for others to use on a network is known as a server.
- A computer that accesses the resources shared by other computers on a network is known as a client.
- In a client/server network, each computer in the network acts as either a server or a client. Server cannot be used as client computer and client computer cannot act as server.
- In peer-to-peer network, all the computers have the same status. Every computer is capable of playing the role of client, server or both at the same time.
- Point-to-Point network is a type of network in which when a message is sent from one computer to another, it usually has to be sent via other computers in the network.
- Local Area Network (LAN) covers a limited area, usually ranging from a small office to a campus of nearby buildings.
- Wide Area Network (WAN) spans a large area, connecting several locations of an organization across cities, countries and continents.
- Metropolitan Area Network (MAN) falls between LAN and WAN. It spans area larger than a LAN but smaller than a WAN, such as a city.
- The physical arrangement of network nodes is known as network topology.
- Bus topology consists of a single central cable known as bus. All the devices are connected to the bus along its length to communicate with each other.
- Ring topology is shaped just like a ring. It is like a bus with both ends connected together.
- In star topology, all the nodes are connected to a central device called switch or hub.
- In mesh topology, all the network nodes are connected to all the other nodes.

- Dial-up modem is a communication device that converts digital signals to analog signals for transmission over telephone line. The analog signals are converted back to digital signals by the modem attached to computer at the receiving end.
- DSL modem is a communication device that provides high-speed connection to Internet.
- ISDN modem is a device that converts digital signals used in computers to the signals that can be transmitted over the ISDN lines.

EXERCISE

- Q1. Select the best answer for the following MCQs.**
- i. In which of the following transmission mode, information is transmitted in both directions but not simultaneously?**

A. Simplex mode	B. Half-duplex mode
C. Full-duplex mode	D. High speed mode
 - ii. In which of the following network, every computer can act as client, server or both at the same time?**

A. Client/server network	B. Peer-to-peer network
B. Point-to-Point network	D. Local area network
 - iii. Which of the following network provides centralized security?**

A. Client/server network	B. Peer-to-peer
C. Point-to-Point network	D. Local area network
 - iv. Which of the following computer shares resources on a network for others to use?**

A. Desktop computer	B. Client
C. Server	D. Microcomputer
 - v. Which of the following topology is most expensive to implement?**

A. Star	B. Bus
C. Ring	D. Mesh
 - vi. In which of the following network topology, switch is required?**

A. Star	B. Bus
C. Ring	D. Mesh
 - vii. Which of the following network is used to provide Cable TV and Internet services?**

A. Local area network	B. Wide area network
C. Metropolitan area network	D. Point-to-Point network
 - viii. Which of the following provides high speed Internet connection?**

A. Dial-up connection	B. DSL connection
C. ISDN connection	D. CDMA connection
 - ix. Which of the following network connects computers across cities, countries and continents?**

A. Local area network	B. Wide area network
C. Metropolitan area network	D. Client/Server network

- Dial-up modem is a communication device that converts digital signals to analog signals for transmission over telephone line. The analog signals are converted back to digital signals by the modem attached to computer at the receiving end.
- DSL modem is a communication device that provides high-speed connection to Internet.
- ISDN modem is a device that converts digital signals used in computers to the signals that can be transmitted over the ISDN lines.

EXERCISE

- Q1. Select the best answer for the following MCQs.**
- i. In which of the following transmission mode, information is transmitted in both directions but not simultaneously?**

A. Simplex mode	B. Half-duplex mode
C. Full-duplex mode	D. High speed mode
 - ii. In which of the following network, every computer can act as client, server or both at the same time?**

A. Client/server network	B. Peer-to-peer network
C. Point-to-Point network	D. Local area network
 - iii. Which of the following network provides centralized security?**

A. Client/server network	B. Peer-to-peer
C. Point-to-Point network	D. Local area network
 - iv. Which of the following computer shares resources on a network for others to use?**

A. Desktop computer	B. Client
C. Server	D. Microcomputer
 - v. Which of the following topology is most expensive to implement?**

A. Star	B. Bus
C. Ring	D. Mesh
 - vi. In which of the following network topology, switch is required?**

A. Star	B. Bus
C. Ring	D. Mesh
 - vii. Which of the following network is used to provide Cable TV and Internet services?**

A. Local area network	B. Wide area network
C. Metropolitan area network	D. Point-to-Point network
 - viii. Which of the following provides high speed Internet connection?**

A. Dial-up connection	B. DSL connection
C. ISDN connection	D. CDMA connection
 - ix. Which of the following network connects computers across cities, countries and continents?**

A. Local area network	B. Wide area network
C. Metropolitan area network	D. Client/Server network

x. Which of the following network topology uses a device called terminator?

- A. Ring topology
B. Mesh topology
C. Bus topology
D. Star topology

Answers

i. B	ii. B	iii. A	iv. C	v. D
vi. A	vii. C	viii. B	ix. B	x. C

Q2. Write short answers of the following questions.

i. Describe any three difficulties a company may face in running a business without having computer network.

Ans: Here are some of the ways a computer network can help your business:

File sharing:

A network makes it easy for everyone to access the same file and prevents people from accidentally creating different versions.

Printer sharing:

If you use a computer, chances are you also use a printer. With a network, several computers can share the same printer.

Share office equipment:

Instead of having one printer, one fax and one scanner per person, you can have just one of each for the whole office if you have them set up to be shared in the network. It is much more cost efficient than individual computers having their own printer.

Communication and collaboration:

It's hard for people to work together if no one knows what anyone else is doing. A network allows employees to share files, view other people's work, and exchange ideas more efficiently.

Data protection:

You should know by now that it's vital to back up your computer data regularly.

As you can see, the advantages of a computer network in your business are numerous and that is the reason it is so popular nowadays. It enhances productivity by using connectivity and sharing of files.

Due to above discussion it is clear that a company may face difficulties in running a business without having computer network.

ii. What is meant by data transmission?

Ans: Data Transmission:

Data transmission is the process of sending data from one device to another. It consists of sender, receiver and the medium which carries the information.

There are three modes of data transmission which are simplex, Half-duplex and Full-duplex.

iii. Differentiate between Half-duplex and Full-duplex transmission modes.

Ans: Half-duplex Transmission Mode:

A Half-duplex mode can send and receive data/information in both directions but not simultaneously. During data transmission, one end is the sender and the other is receiver.

Examples:

Half-duplex transmission is used in ATM machines for withdrawal of cash, money transfer and paying bills, etc. Half-duplex transmission is shown in Fig.

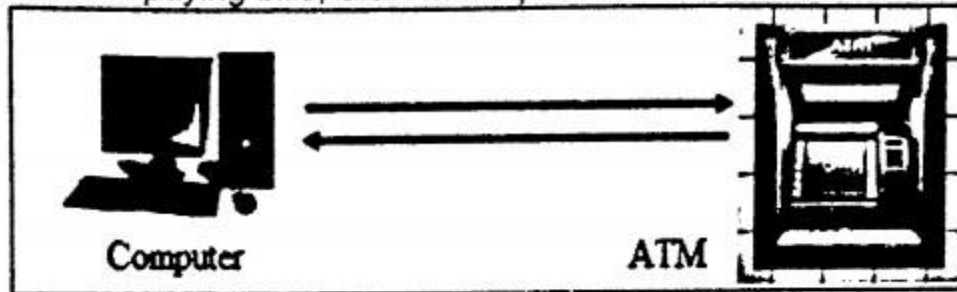

Transmission through Half – duplex mode

Full-duplex Transmission Mode:

A Full-duplex mode is used to transmit data/information in both directions simultaneously as shown in Fig.

A Full-duplex mode can transmit more data/information at higher rate.

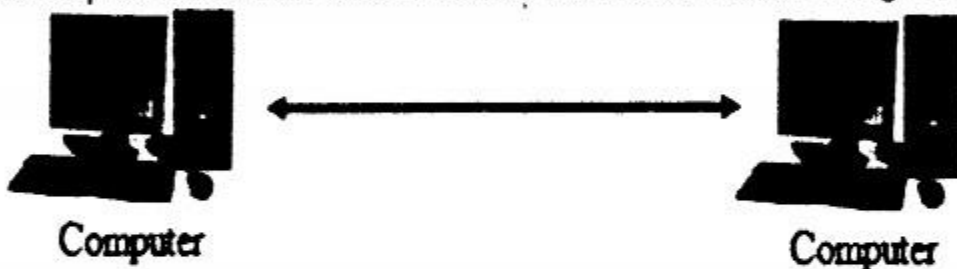

Transmission through Full – duplex mode

Examples:

Examples of Full-duplex mode are communication between computers in a network and communication over telephone line.

iv. Define network architecture?**Ans: Network Architecture:**

Network architecture refers to layout of network that consists of computers, communication devices, software, wired or wireless transmission of data and connectivity between components.

A computer network can be as small as two computers linked together by a single cable whereas large networks connect thousands of computers and other devices.

Types of Network Architectures:

Three types of network architectures are commonly used which are:

- Client/server network
- Peer-to-peer network
- Point-to-point network

v. Differentiate between a server and a client computer.**Ans: Server Computer:**

A Server is a main computer in a network which is used to manage network resources and facilitates other computers.

Client Computer:

Clients are computers in a network that access services made available by a server.

In a client/server network, each computer on the network acts as either a server or a client. Servers are not used as client computers and client computers are not used as servers.

In a client/server network, server shares its resources such as hard disk, printers and Internet connection with client computers.

vi. Compare LAN and WAN.

Ans: Local Area Network (LAN):

Local area network is commonly used network. It is a network that covers a limited area, usually ranging from a small office to a campus of nearby buildings.

Examples:

Examples of LAN include networks within a school, college, business and organization. A local area network is shown in Fig.

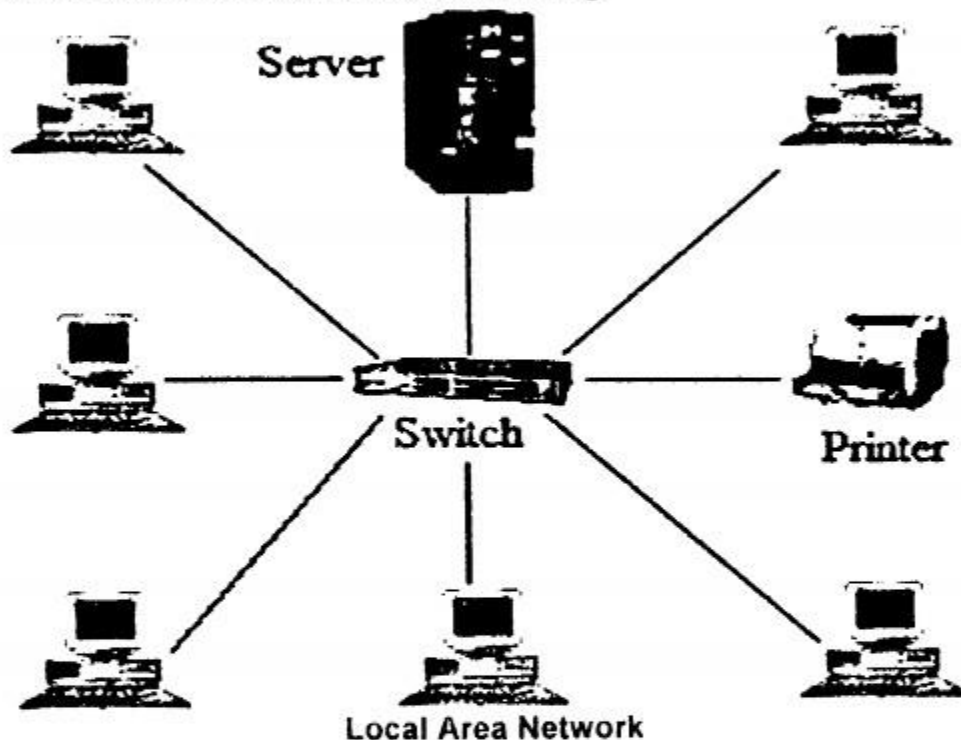

Characteristics of LAN:

- i) LAN is restricted to a limited geographical area.
- ii) Data transmission speed is fast.
- iii) Data communication problems rarely occur.
- iv) Transmission medium is owned by the user organization.

Wide Area Network (WAN):

Wide Area Network spans a large area, connecting several locations of an organization across cities, countries and continents. A WAN is often made up of two or more LANs and/or MANs at each location of an organization and these LANs might be connected together to form a WAN.

Examples:

Examples of WAN are the networks used in banks, airlines and national database authorities like NADRA in Pakistan. Internet is another good example of WAN. A wide area network is shown in Fig.

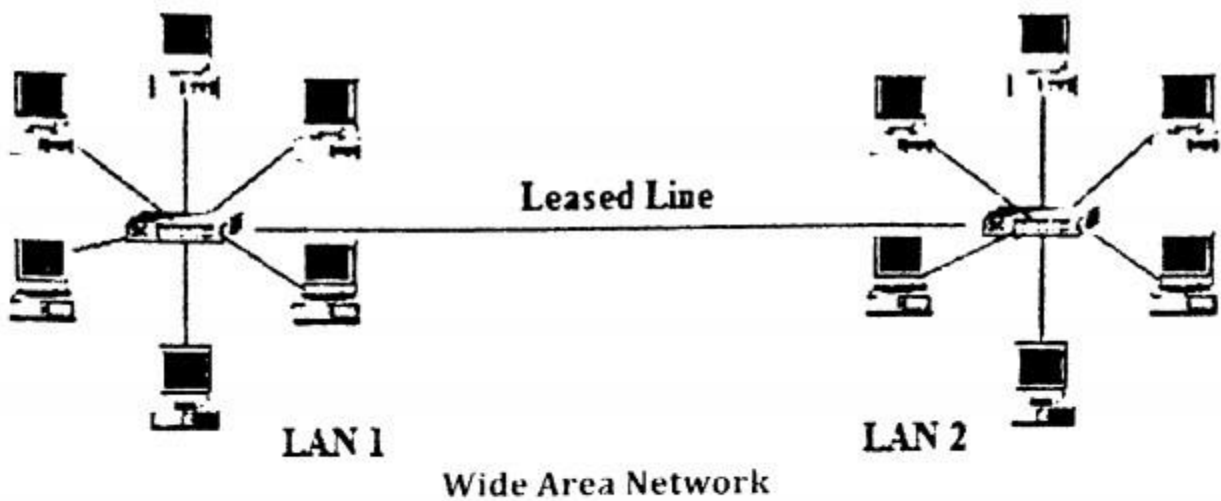

Characteristics of WAN:

- i) WAN spans large geographical area. It can connect computers between cities and countries.
- ii) Data transmission speed is slow.
- iii) Data communication problems often occur.
- iv) Transmission medium is leased lines or public systems such as telephone lines or satellite links.

vii. Why star topology is more reliable than bus or ring topologies?

Ans: Due to following reasons star topology is more reliable than bus or ring topologies.

- Provides fast communication between computers.
- Easy to connect new devices to the network.
- Easy to detect and fix faults.
- Failure of one computer does not stop functioning of the entire network.

viii. Mention any three problems which may occur if peer-to-peer network is used for a large number of users in an organization.

Ans: Problems of Peer-to-Peer Networks:

- i) In a peer-to-peer network, each computer can play the role of server, client or both at the same time.
- ii) Peer-to-peer networks are suitable for a small number of users, ranging between two to ten computers. Large peer-to-peer networks become difficult to manage.
- iii) It does not provide centralized security. No single person is assigned to administer the resources of network. Individual users have complete control over resources of their computers.

ix. What is ISDN?

Ans: ISDN:

ISDN stands for Integrated Services Digital Network. It provides a maximum speed of 128Kbps which is more than Dial-up connection but less than DSL. It can transmit both voice and data at the same time over a single cable. It requires that the user has ISDN digital telephone service from telephone company and uses a faster modem than Dial-up modem. ISDN service is being replaced by faster DSL service.

x. What is CDMA technology?

Ans: CDMA Technology:

CDMA stands for Code Division Multiple Access. It is a wireless cellular communication technology. CDMA services include short messaging, voice, data and video transmission. It can provide speed of several Mbps for video transmission.

Q3. Write long answers of the following questions.

i. What are the advantages of using networks?

Ans: Advantages of using networks:

The following are some common uses of networks.

Hardware Sharing:

Network allows sharing of computer hardware such as hard disk and printer. A hard disk can be attached to a server to share it with other network users. A single hard disk can provide storage space to many users.

A printer can also be connected to a computer to share it with all the other computer users across the network. Every user on network can use it for printing documents and there is no need to buy a printer for every user.

Software Sharing:

Application software can be installed on a server and shared over the network. There is no need to install it on all the computers in network.

File Sharing:

A user of a network can easily share files with other users over the network. A user can place a file in a shared location on one computer and make it available to other users.

Users can access, view and modify information stored on another computer in the network.

Internet Sharing:

A single high speed Internet connection can be shared with all the users over a network. There is no need to provide a separate Internet connection to every user on the network.

ii. Describe Client/Server and Peer-to-Peer networks.

Ans: Client/Server Network:

A Server is a main computer in a network which is used to manage network resources and facilitates other computers.

Clients are computers in a network that access services made available by a server.

In a client/server network, each computer on the network acts as either a server or a client. Servers are not used as client computers and client computers are not used as servers.

In a client/server network, server shares its resources such as hard disk, printers and Internet connection with client computers. A client/server network is illustrated in Fig.

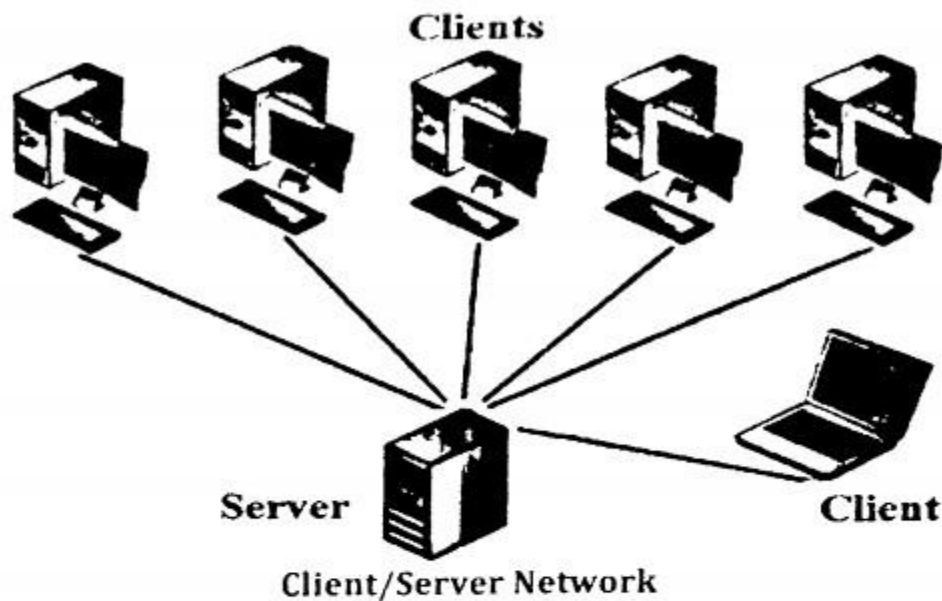

Characteristics of Client/Server Networks:

- i) Client/server network can be as small as two computers and it can have hundreds and even thousands of computers as well.
- ii) It provides centralized security to ensure that resources are not accessed by unauthorized users.
- iii) In a client/server network, a person known as Network Administrator is responsible for sharing resources, creating user accounts and assigning privileges to all the users of the network.

Peer-to-Peer Network:

In Peer-to-Peer network all computers have the same status. Every computer is capable of playing the role of client, server or both at the same time. Each computer on the network is known as peer. A peer on the network can share as well as access available resources on the network. Peer-to-peer network is illustrated in Fig.

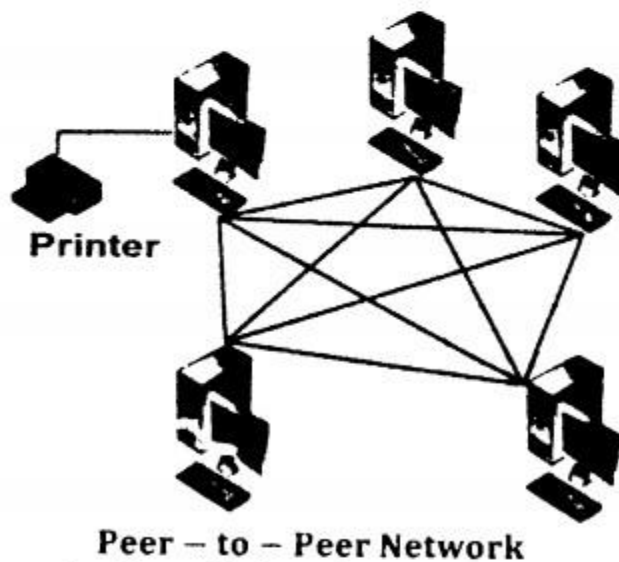

Characteristics of Peer-to-Peer Networks:

- i) In a peer-to-peer network, each computer can play the role of server, client or both at the same time.

- ii) Peer-to-peer networks are suitable for a small number of users, ranging between two to ten computers. Large peer-to-peer networks become difficult to manage.
- iii) It does not provide centralized security. No single person is assigned to administer the resources of network. Individual users have complete control over resources of their computers.

iii. **Describe the types of networks based on area covered.**

Ans: Types of Networks Based on Geographical Area:

Based on the geographical distance covered, computer networks are classified into Local Area Network, Wide Area Network and Metropolitan Area Network.

Local Area Network (LAN):

Local area network is commonly used network. It is a network that covers a limited area, usually ranging from a small office to a campus of nearby buildings.

Examples:

Examples of LAN include networks within a school, college, business and organization. A local area network is shown in Fig.

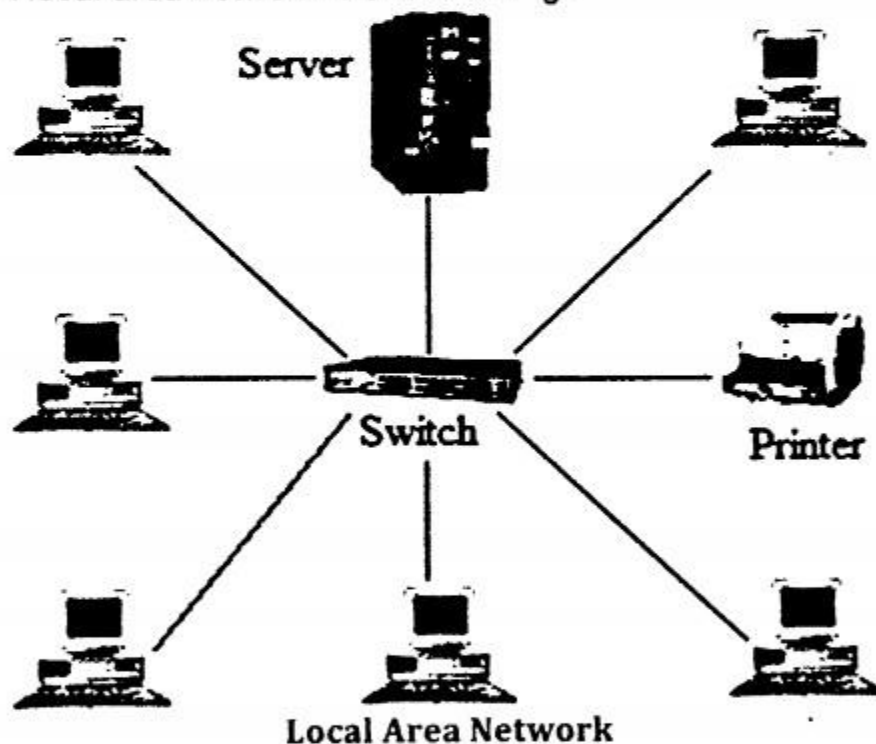

Characteristics of LAN:

- i) LAN is restricted to a limited geographical area.
- ii) Data transmission speed is fast.
- iii) Data communication problems rarely occur.
- iv) Transmission medium is owned by the user organization.

Wide Area Network (WAN):

Wide Area Network spans a large area, connecting several locations of an organization across cities, countries and continents. A WAN is often made up of two or more LANs and/or MANs at each location of an organization and these LANs might be connected together to form a WAN.

Examples:

Examples of WAN are the networks used in banks, airlines and national database authorities like NADRA in Pakistan. Internet is another good example of WAN. A wide area network is shown in Fig.

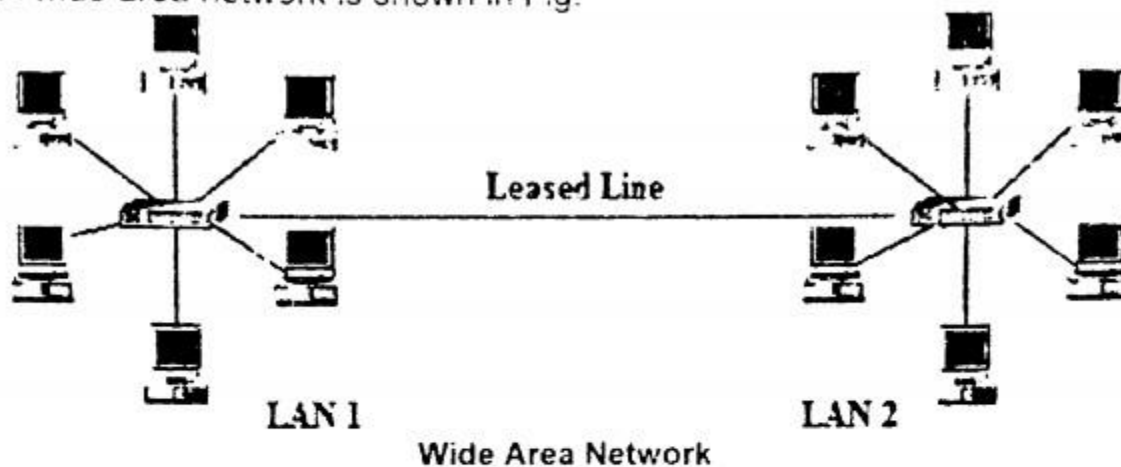

Characteristics of WAN:

- i) WAN spans large geographical area. It can connect computers between cities and countries.
- ii) Data transmission speed is slow.
- iii) Data communication problems often occur.
- iv) Transmission medium is leased lines or public systems such as telephone lines or satellite links.

Metropolitan Area Network (MAN):

A Metropolitan Area Network (MAN) falls between LAN and WAN. It spans area larger than a LAN but smaller than a WAN. A metropolitan area network is shown in Fig.

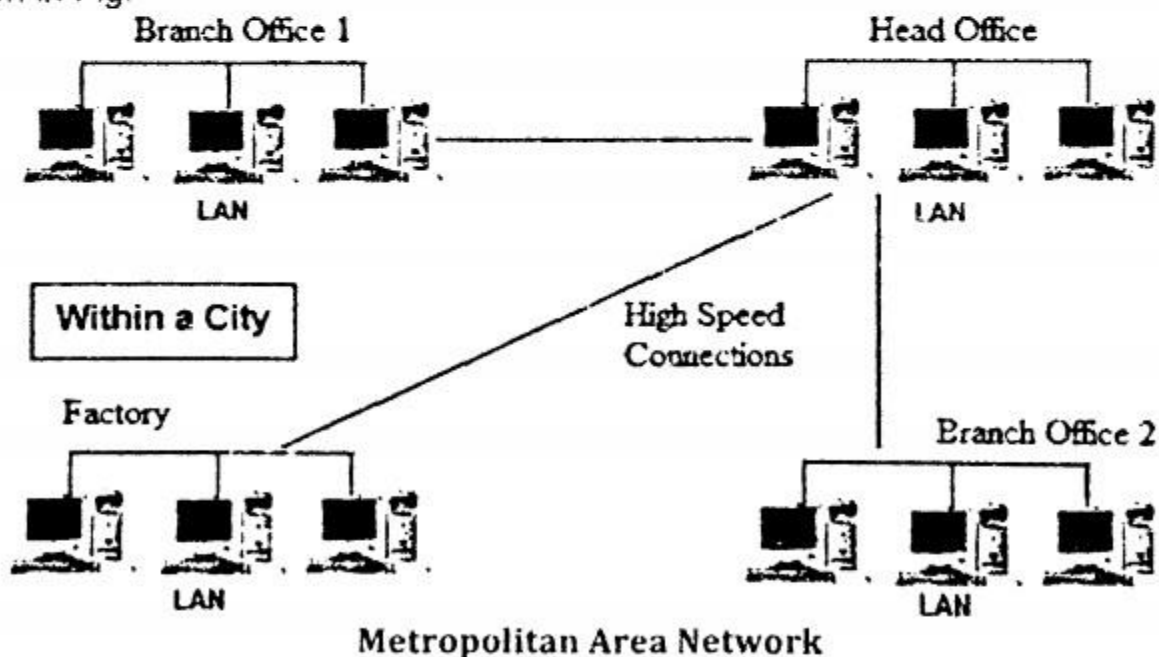

Examples:

Examples of MAN are networks used by telecommunication companies for providing Cable TV and Internet services.

Characteristics of MAN:

- i) MAN can connect computers within several blocks of buildings to entire city.

- ii) Data transmission speed is slower than LAN but faster than WAN.
- iii) Fibre optic cable or wireless microwave transmission is used as communication medium.

Personal Area Network (PAN):

A personal area network (PAN) is a computer network organized around an individual person. Personal area networks typically involve a mobile computer, a cell phone and/or a handheld computing device such as a PDA. Users can use these networks to transfer files including emails, calendar appointments, photos and audio/video files.

Personal area networks can be wired or wireless. USB and FireWire technologies often link together a wired PAN, while wireless PANs typically use Bluetooth or sometimes infrared connections.

Example of wireless PAN using Bluetooth technology:

The following is the example of wireless PAN using Bluetooth technology.

Bluetooth Network:

The process of setting up a Bluetooth network is referred to as "Pairing". Pairing is done through interaction between two users. The user interaction is required to confirm the identity of the devices.

When pairing process completes, a network forms between the two devices and now the devices can communicate with each other. It is possible to pair one device to multiple other devices. Bluetooth creates a secure network. A Bluetooth network connecting various Bluetooth devices is shown in Fig. *



Bluetooth Network

Characteristics of Bluetooth Communication

- i) Bluetooth transmission eliminates the need of cable to form a network.
- ii) Transmission is secure, reliable and fast.
- iii) It creates Personal Area Network in which Bluetooth devices are close to each other.
- iv) It can transmit text, images, audio files and video files.

Internet (International Network):

Internet is the largest computer network that connects millions of computers all over the world. Computers on the Internet are connected together using telephone lines, fiber optics or wireless signals. Each computer on the Internet has an IP address. IP stands for Internet Protocol. It identifies each computer on the Internet with its location.

Internet has brought a huge revolution in our daily life. It allows people to send e-mail, chat with friends around the world and obtain information on any topic.

Computer users pay bills, do shopping, find jobs, work at home and do reservation for trains, flights, and hotels through Internet. Social networking websites such as Facebook and Twitter allow millions of people all over the world to communicate with each other and share their views and ideas.

World Wide Web (www) or Web in short, is the most popular and widely used system to access the Internet. It is a collection of websites available on the Internet. A website contains related webpages that can be accessed using a browser such as Google Chrome or Internet Explorer.

To access a website, computer users enter a string of characters called Uniform Resource Locator (URL) into a browser. For example to access the website of Federal board, the user will enter the URL *www.fbise.gov.pk* into a browser.

iv. Explain the types of network topologies.

Ans: Network Topology:

The physical arrangement of network nodes is called network topology. A node represents a computer or a network device.

Types of Network Topologies:

Four types of network topologies are commonly used which are bus, ring, star and mesh.

Bus Topology:

It is the simplest network topology. It consists of a single central cable known as bus. All the devices are connected to the bus along its length to communicate with each other as shown in Fig. A computer sends a message on the bus. The computer to whom the message is sent receives it while others ignore it. At each end of bus a device called terminator is attached so that the signals do not bounce back on the bus causing errors.

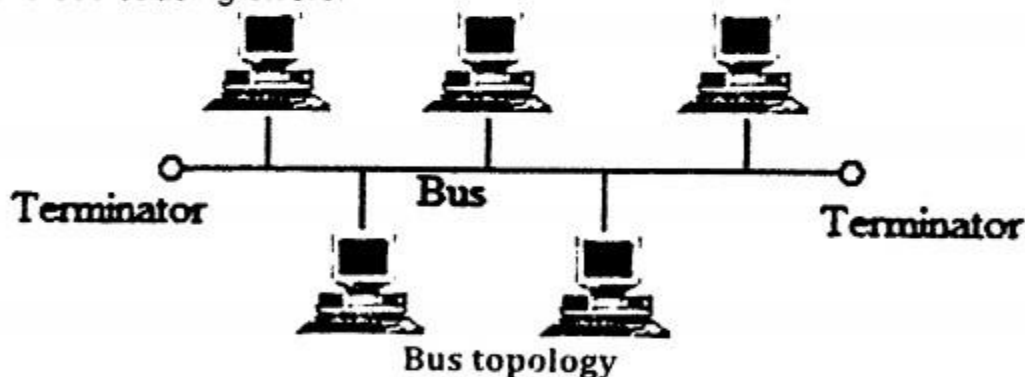

Advantages of Bus Topology:

- Lowest cost topology to implement due to short cable length.
- Easy to add new computers.
- Easy to setup as compared to Star or Mesh topology.
- Suitable for small networks.

Limitations of Bus Topology:

- If bus is damaged at any point, the entire network stops working.
- Difficult to detect and fix faults.

Ring Topology:

The ring network topology is shaped just like a ring as shown in Fig. It is like a bus with both ends connected together. All the messages travel in the same direction. Message from one node is sent to the next node. It is received by it if it is addressed to it otherwise it is ignored and passed on to the next until the destination is reached.

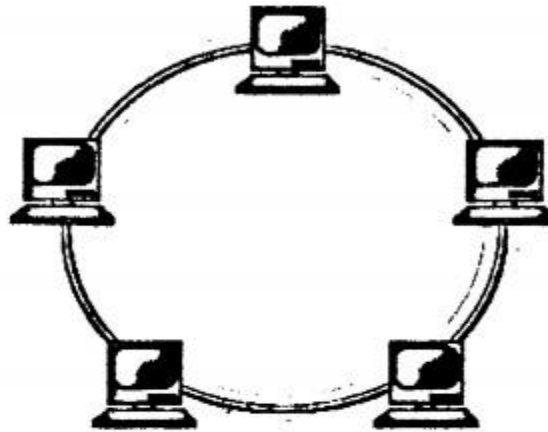

Ring topology

Advantages of Ring Topology:

- High network performance.
- Server or switch is not required to manage the network.
- All the computers have equal opportunity to transmit data.

Limitations of Ring Topology:

- If ring is broken at any point, the entire network stops functioning.
- Detection of fault is difficult.
- If any computer in the ring is not working the whole network is affected.
- Expensive than Star and Bus topologies.

Star Topology:

In star topology all the nodes are connected to a central device called switch or hub as shown in Fig. It is one of the commonly used network topologies. A switch can connect 4, 8, 16, 24 or 32 nodes. A switch can be connected to another switch to expand the network.

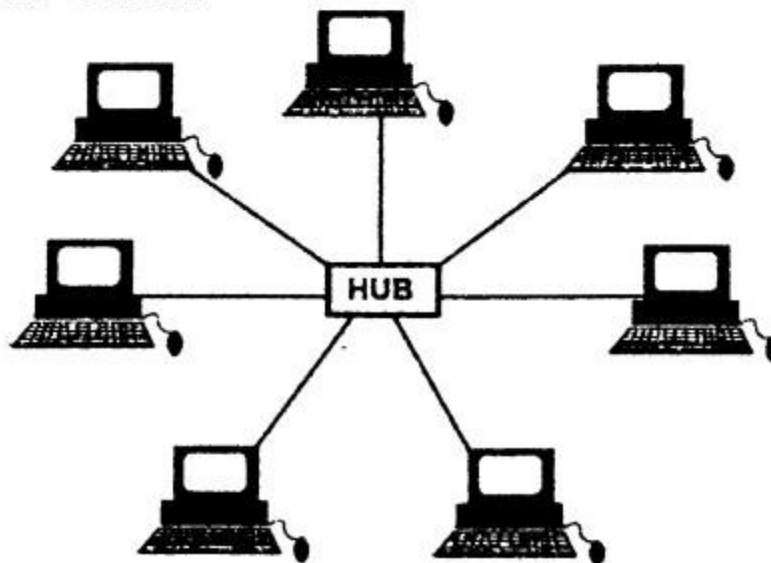

Star topology

Advantages of Star Topology:

- Provides fast communication between computers.
- Easy to connect new devices to the network
- Easy to detect and fix faults.
- Failure of one computer does not stop functioning of the entire network.

Limitations of Star Topology:

- At least one switch/hub is required for connecting two computers.
- Lengthy cable is required to connect all the computers to the switch.
- Costly to implement.

Mesh Topology:

In mesh network topology, all the network nodes are connected to all the other nodes as shown in Fig. Message sent on a mesh network, can take any possible path from source to destination. It is not commonly used since it is costly and difficult to implement.

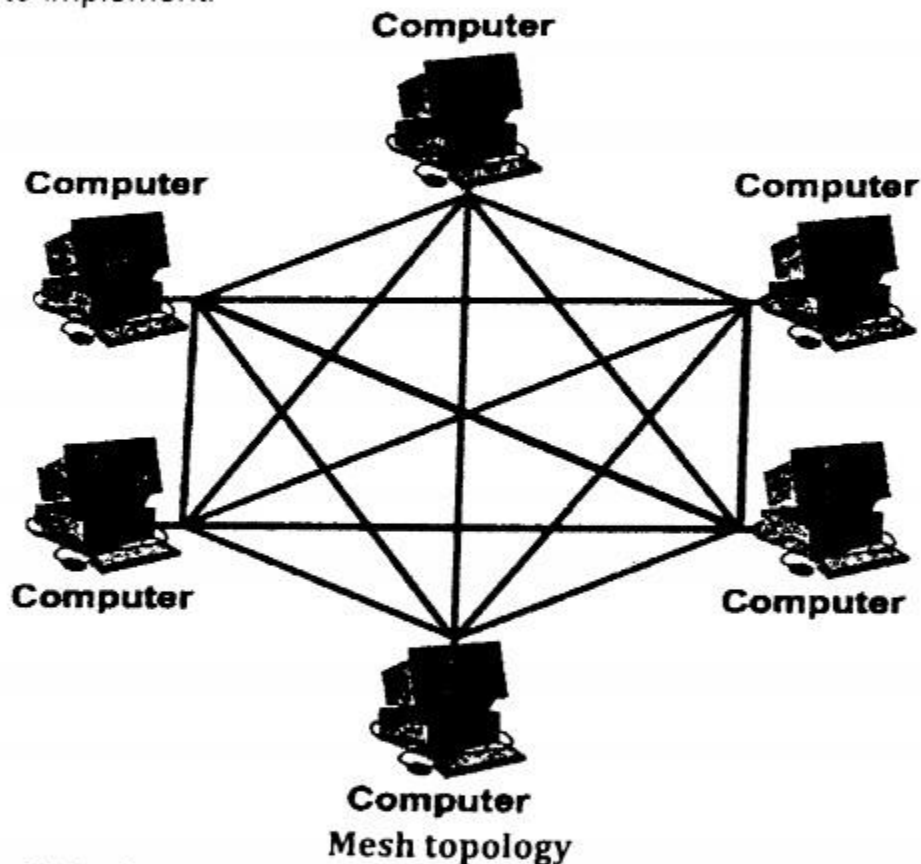

Advantages of Mesh Topology:

- It is the most reliable network topology.
- Alternative paths are available in case a path is broken from source to destination.

Limitations of Mesh Topology:

- Most expensive topology to implement since it requires more cable than Bus, Ring or Star topologies.
- Difficult to implement as compared to other topologies.
- Difficult to add new computer.

v. Write a note on Dial-up and DSL Internet connections.

Ans: Dial-up Line:

Dial-up line uses standard telephone lines for Internet connection. It requires a Dial-up modem that provides a maximum Internet connection speed of 56Kbps.

The main advantage of using Dial-up line is that it uses complex network of telephone lines that allows data to be transmitted to almost any location in the world. It is becoming outdated due to very slow Internet connection.

DSL:

DSL (Digital Subscriber Line) provides a very high speed broadband Internet connection. It is called broadband because it has broad range of frequencies for transmitting digital data.

Broadband:

Any type of Internet speed that is 256Kbps or above is known as broadband.

A DSL modem is required for setting up the DSL Internet connection. Internet Service Providers (ISPs) have several DSL speeds available with different monthly rates.

Lab Activities

Activity:

The students should be shown/explained a switch and network card and its use to create a local area network in school computer lab. The cables and connectors used for creating a local area network (LAN) should also be physically shown to students.

CHAPTER 6

COMPUTER SECURITY AND ETHICS

SHORT AND LONG QUESTIONS

Q.1 Define cybercrime.

Ans: Cybercrime:

Cybercrime refers to any crime that is committed by means of computer and Internet technology by having unlawful access to others' computers.

Many governments have passed cybercrime bill that carry fines and prison sentences for cybercriminals.

Q.2 Describe some commonly committed cybercrimes.

Ans: Commonly committed cybercrimes:

The following are the commonly committed cybercrimes.

- i. Computers have been involved in crimes such as fraud, kidnapping, murder and crimes related with stealing money from bank and credit card company.
- ii. Criminals use Internet to steal personal information of other users and commit various types of cybercrimes. Personal information includes username, password, credit card number, bank account number, etc.
- iii. Downloading illegal software, music files and videos are also cybercrimes.
- iv. Internet harassment or cyber bullying is also a serious crime committed by cybercriminals. Internet harassment includes sending threatening e-mail, spreading rumors or virus, making defamatory comments, sending pornography or other bad material.
- v. Making negative comments about an individual on Internet can damage reputation or cause physical or mental harm to the victim.

Q.3 What are computer viruses?

Ans: Computer Viruses:

Some computer experts create malware such as virus, spyware, worm etc. and spread through Internet. It is very importance to understand how malware spreads and how to protect computer from them.

It is very difficult to list all the symptoms of infected computers. The reason for this is that there are hundreds and thousands of malicious programs and new ones are created every day. Sometime, some infected computers do not show any symptom and the user thinks that his computer is not infected.

For Your Information

Firewall is a software or piece of hardware used to prevent unauthorized Internet users from accessing computer systems that are connected to Internet.

Tip

To create a strong password, you should combine upper-case and lower-case letters, numbers and special symbols.

Q.4 Describe the term multimodal authentication.

Ans: Multimodal Authentication:

Multimodal authentication means combination of two or more types of authentication methods. Normally, authentication methods use a single source of information for authentication such as features of face, fingerprint, hand geometry, access cards, etc. Multimodal authentication uses multiple sources of information for identification.

For example, fingerprint and face recognition can be combined for a multimodal biometric authentication system. As another example, a multimodal authentication can combine access card and PIN to open security gate.

Q.5 Describe computer ethics in information accuracy, information ownership, intellectual property rights, software piracy and information privacy.

Ans: Areas of Computer Ethics:

The following are main areas of computer ethics.

- | | |
|-------------------------|---|
| ● Information accuracy | ● Information ownership/Intellectual rights |
| ● Intellectual Property | ● Software piracy |
| ● Information privacy | ● Internet and Privacy |

Information Accuracy:

Information stored on computers must be accurate, up-to-date and complete. If wrong information is entered in computer, it can be very harmful. People may suffer because of inaccurate information stored on computer. For example, a credit card holder may be wrongly blacklisted if wrong information is entered into the computer.

Information Ownership/Intellectual Rights:

Information ownership or intellectual rights mean persons who create ideas in any form are the actual owners. Ideas may be in the form of poems, plays, novels, films, drawings, paintings, software, etc. Intellectual rights protect creative work from unauthorized use by other people and allow creators to benefit financially from their work.

Intellectual Property:

Intellectual property means the legal rights of an individual or a corporation that result from intellectual activity in literary, artistic, scientific and industrial fields. Countries have law to protect intellectual property to foster innovation and promote creativity.

Software Piracy:

Software piracy means making illegal copies of software for use or sale for financial benefit. When computer users buy licensed software, they have the right to use it on a single computer. Software Copyright Law does not allow to make illegal copies of software and install it on other computers or sell it. It allows software developers to benefit financially from their work.

Information Privacy:

Information privacy refers to an individual's right to the privacy of personal information. In modern information age, people are concerned that computers may be taking away their privacy. The Data Protection Act (Law) protects the rights of the individuals against misuse of personal information by organizations. Organizations that hold the information should not allow unauthorized people to have access to information or disclose it to anyone outside the organization.

Internet and Privacy:

People who use Internet are worried that it may be eroding their privacy. Internet users post their personal information such as full name, date of birth, place of residence, phone numbers, pictures, videos etc. on the Web and it stays there. Internet users enter personal information in websites to sign up or register for services without realizing that this may lead to invasions of privacy. This information can be accessed by hackers and used for harmful purpose. This poses a serious threat to privacy as unauthorized people can access personal information of individuals. Therefore, people are concerned about invasion of computer and Internet technology into people's privacy.

KEY POINTS

- Computer security refers to protecting computer hardware, software and information stored on computer from threats.
- A crime that is committed by means of computer and Internet technology is known as cybercrime.
- A person who illegally breaks into others' computer systems is known as hacker.
- A person who uses special tools for breaking into computer systems is known as cracker.
- Malware means malicious software. It comprises of harmful software such as virus, worm, spyware etc. that are threats to all computer users.
- Malware spreads through infected flash drives, CDs, pirated software, Internet, e-mail attachments and devices that are plugged into computer's USB ports.
- Authentication means identifying a person based on a method such as Username and Password, Personal Identification Number, Access Card or Biometrics.
- Authorization verifies that an authenticated person has permission to access computer system and use it.

- Personal Identification Number (PIN) is a confidential numeric password used to authenticate a user to get access to computer system.
- Access cards are very similar in appearance to credit cards. They are used to open security gates, parking barrier and doors of hotel rooms.
- Biometrics is a method based on measurement of features of face, fingerprint, hand geometry, signature and voice for authentication of individuals.
- Multimodal authentication combines two or more types of authentication methods such as face and fingerprint for identification of individuals.
- Computer ethics is concerned with the moral guidelines for the ethical use of computer technology. It specifies what is right and what is wrong when using computers.
- Information ownership or intellectual rights mean a person who creates an idea in any form is the actual owner. Intellectual rights protect creative work from unauthorized users and allows creator to benefit financially.
- Software piracy means making illegal copies of computer software for use or sale for financial benefit.

EXERCISE

Q1. Select the best answer for the following MCQs.

- i. **What is a person who illegally breaks into others' computer systems called?**

A. Computer engineer	B. System programmer
C. Hacker	D. Cracker
- ii. **What is a person who uses special tools for breaking into computer systems called?**

A. Computer engineer	B. System programmer
C. Hacker	D. Cracker
- iii. **Which malware spreads automatically in computer networks and replicates itself?**

A. Virus	B. Worm
C. Adware	D. Spyware
- iv. **Which of the following malware displays advertisements on the screen?**

A. Virus	B. Worm
C. Adware	D. Trojan
- v. **Which of the following authentication method is used for opening security gates?**

A. Username and password	B. Personal Identification Number
C. Access card	D. Biometrics
- vi. **Which of the following authentication method is most reliable?**

A. Username and password	B. Personal Identification Number
C. Access card	D. Biometrics

- Personal Identification Number (PIN) is a confidential numeric password used to authenticate a user to get access to computer system.
- Access cards are very similar in appearance to credit cards. They are used to open security gates, parking barrier and doors of hotel rooms.
- Biometrics is a method based on measurement of features of face, fingerprint, hand geometry, signature and voice for authentication of individuals.
- Multimodal authentication combines two or more types of authentication methods such as face and fingerprint for identification of individuals.
- Computer ethics is concerned with the moral guidelines for the ethical use of computer technology. It specifies what is right and what is wrong when using computers.
- Information ownership or intellectual rights mean a person who creates an idea in any form is the actual owner. Intellectual rights protect creative work from unauthorized users and allows creator to benefit financially.
- Software piracy means making illegal copies of computer software for use or sale for financial benefit.

EXERCISE

Q1. Select the best answer for the following MCQs.

- i. **What is a person who illegally breaks into others' computer systems called?**

A. Computer engineer	B. System programmer
C. Hacker	D. Cracker
- ii. **What is a person who uses special tools for breaking into computer systems called?**

A. Computer engineer	B. System programmer
C. Hacker	D. Cracker
- iii. **Which malware spreads automatically in computer networks and replicates itself?**

A. Virus	B. Worm
C. Adware	D. Spyware
- iv. **Which of the following malware displays advertisements on the screen?**

A. Virus	B. Worm
C. Adware	D. Trojan
- v. **Which of the following authentication method is used for opening security gates?**

A. Username and password	B. Personal Identification Number
C. Access card	D. Biometrics
- vi. **Which of the following authentication method is most reliable?**

A. Username and password	B. Personal Identification Number
C. Access card	D. Biometrics

- vii. Which of the following authentication method is based on features of individuals such as face, fingerprint and voice?
 A. Username and password B. Personal Identification Number
 C. Access card D. Biometrics
- viii. What is making illegal copies of copyright software for use on other computers or sale called?
 A. Information privacy B. Intellectual rights
 C. Software piracy D. Information ownership
- ix. Which of the following malware gathers information about user activities on computer?
 A. Virus B. Worm
 C. Adware D. Spyware
- x. Which of the following authentication methodology is used to draw cash from ATM?
 A. Username and password B. Personal Identification Number
 C. Access card D. Biometrics

Answers

i. C	ii. D	iii. B	iv. C	v. C
vi. D	vii. D	viii. C	ix. D	x. B

Q2. Write short answers of the following questions.

i. Define cybercrime.

Ans: Cybercrime:

Cybercrime refers to any crime that is committed by means of computer and Internet technology by having unlawful access to others' computers.

ii. What is the importance of computer security?

Ans: Computer Security:

Computer security refers to protecting computer hardware, software and information stored on computer from threats.

Importance of Computer Security:

Computer users often exchange information with each other or communicate over Internet. This can infect a user's computer with virus or other types of malicious software.

Computer security or safety is important for computer users to protect their computer from different threats. It is necessary to install security software such as firewall, antivirus and spyware on computers.

iii. Differentiate between hacker and cracker.

Ans: Hacker:

A person who illegally breaks into others' computer systems is known as hacker. Hacking is a cybercrime.

- Hackers are computer experts who try to gain unauthorized access to computer systems for stealing and corrupting information.
- Most of the hackers break into computers for financial benefits. They try to get credit card details or bank account information so that they can steal money.

- Hackers have in-depth knowledge of network programming and can create tools and malicious software for others to break into networks and create problems.

Example:

For example, a hacker develops software in which a dictionary file is loaded that contains all the dictionary words. When the software is run it tries all the dictionary words one by one as password to hack a computer. This method works if the user is having a simple password that exists in the dictionary.

Cracker:

Cracker is a computer user who breaks into computer systems without permission using hacking tools for personal gain or damage and commits cybercrimes

- Most of the crackers do not have professional computer skill to hack computer systems but they have knowledge about using hacking tools.
- Crackers break into computers and cause serious damage. They also break into Web servers and replace the home page of a website with a page of their own design.
- These criminals are dangerous and harder to catch.

Example:

For example, a cracker can install a key logger on another user's computer through Internet. A key-logger is software which records every typed letter on the keyboard. When the user uses Facebook and enters the Facebook account details, it will get recorded in the cracker's computer. Now, he can easily hack the Facebook account.

iv. Describe any five symptoms of malware.

Ans: Common Symptoms of Malware Attacks:

A list of common symptoms of infected computers is given below.

- The computer does not start or it reboots automatically when it is on.
- Different types of error messages appear on the screen.
- Unexpected messages appear on the screen.
- Programs do not run in a normal way.
- Computer is running very slow.
- New files or folders are created on the hard disk.
- Folders are deleted or changed on the hard disk.
- Hard disk activity is noticed without running any program.
- Web browser does not run in a normal way.
- Strange noise is heard when the computer is on.

v. Differentiate between authentication and authorization.

Ans: Authentication:

Authentication means identifying a person based on a method such as Username and Password, Personal Identification Number (PIN), Access Card or Biometrics. It verifies who the person is.

Authorization:

Authorization means to give someone permission to do something.

Example:

For example when a user wants to login to his email account, he is asked to enter username and password to verify his identity. This is authentication.

If correct username and password are entered, the user is authorized or allowed to check his emails, send email or perform other tasks related with email service. This is authorization

vi. Which authentication methodology provides highly secure identification and verification? Justify your answer.

Ans: Biometrics provides highly secure identification and personal verification technologies.

Biometrics refers to authentication methods based on physical characteristics of individuals such as features of face, hand geometry, retina, voice and fingerprint.

Biometrics based systems are used for financial transactions, electronic banking and personal data privacy.

Biometrics provides more accurate authentication than using username and password or PIN. Biometrics is associated with a particular individual. Hence, it cannot be borrowed, stolen or forgotten. Forging in biometrics is practically impossible.

vii. What is meant by information privacy?

Ans: Information Privacy:

Information privacy refers to an individual's right to the privacy of personal information. In modern information age, people are concerned that computers may be taking away their privacy.

The Data Protection Act (Law) protects the rights of the individuals against misuse of personal information by organizations. Organizations that hold the information should not allow unauthorized people to have access to information or disclose it to anyone outside the organization.

viii. Give any three drawbacks of software piracy?

Ans: Disadvantages/Drawbacks of software piracy:

Pirated Software:

Software piracy refers to making of unauthorized copies of copyrighted software and distributing it. Pirated software on CDs is a very common source of spreading malware on computers because these are often infected.

If users download pirated music, movies, programs, etc. for free, their computers may be infected because pirated downloads often contain viruses, spyware or other malicious programs.

OR (Second Answer)

- 1. It's illegal:** making unauthorized copies of software is a federal crime.
- 2. It's risky:** if you downloading pirated software from internet, it is more likely to be infected with computer viruses which can damage your computer system.
- 3.** They do not provide after-sales services.
- 4.** Software piracy slows the economic growth rates of developing because it discourages new software developers from entering the market and slows down the industry's ability to bring new and innovative solutions to consumers.

5. Downloading files illegally have a risk of viruses and Spyware! Pirated software can carry viruses or may not function at all.
6. Unlicensed users do not receive quality documentation. It also deprives consumers of the basic protections offered by properly licensed software like money-back guarantees, installation support, maintenance releases, and upgrade rebates.
7. Piracy can expose end-users to potential risks of identity theft if criminals who sell counterfeit software CDs obtain a buyer's name, address, credit card and other information during purchase. This increases identity theft risks.

ix. **What types of problems may be faced if computer users do not comply with the moral guidelines of computer ethics?**

Ans:

1. Computer users can use Computer to harm other people.
2. Computer users can use Computer to break into others' computer systems to steal, change or destroy information.
3. Computer users can read documents and e-mails of other users without their consent.
4. Computer users can use Computer to make illegal copies of copyright software and sell it for financial benefit.
5. Computer users who have special computer knowledge and ability will create malicious software (such as computer virus) and spread it to other computers.
6. Computer users can commit any type of crime with the help of computer technology.
7. Computer users can not respect the privacy of others.

x. **Name any three places where authentication of people is required.**

Ans: Username and password are used to authorize users to have access to computer systems, e-mail account, bank account and other services available on computer.

PINS are most commonly used with debit and credit cards in retail stores and many other places for payment of bills. It is also used with ATM cards to withdraw cash from ATM machines.

Access cards are commonly used to open security gates in offices where unauthorized people are not allowed to enter. Access cards are also used to open barriers in parking areas. They are an alternative to key for opening hotel room, etc.

Biometrics provides highly secure identification and personal verification technologies. Biometrics based systems are used for financial transactions, electronic banking and personal data privacy.

Q3. Write long answers of the following questions.

i. **Define malware and describe its types.**

Ans: Malware:

Malware is malicious software. It comprises of a number of harmful software that are threats to all computer users. Malware is created for attack on privacy, spying, destruction and financial benefits.

Types of malware:

Most common types of malware are:

- Computer viruses
- Spyware
- Worms
- Adware

● Computer Viruses:

A computer virus is a type of malware that spreads by inserting a copy of itself into another program or file.

- Most of the viruses are attached to executable files.
- Viruses spread and infect other files when a computer user opens the infected program or file.
- Viruses also spread when infected files are transferred from one computer to another through network, USB flash drive, CD/DVD or infected e-mail attachments.
- Some viruses are not very harmful they are simply annoying while others can seriously damage the hardware, software or the information stored on the computer.
- Viruses can slow down the computer and some can even stop its operation.

Examples of viruses:

Examples of viruses are I Love You, MyDoom, etc. I Love You is an e-mail virus that infected computer when user opened an e-mail attachment named "I Love You" MyDoom virus was discovered in 2004. It quickly infected about one million computers. Virus detection is shown in Fig.

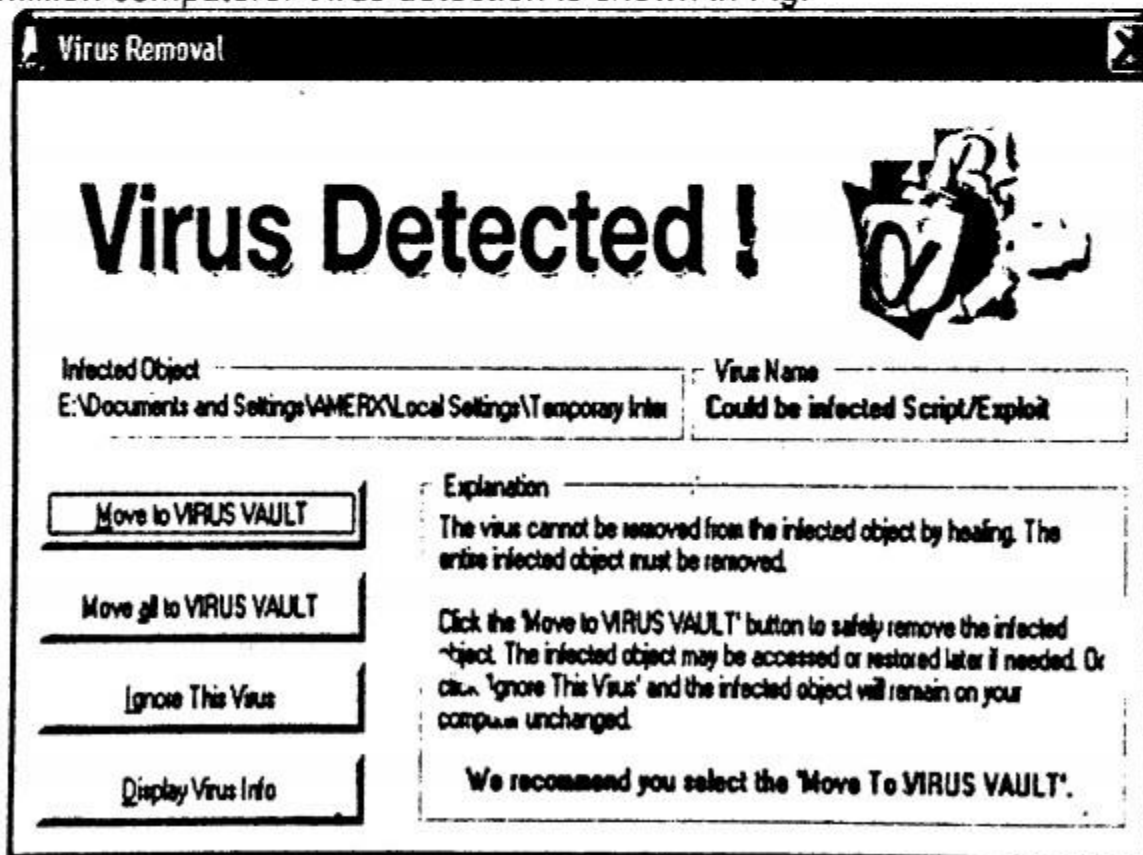

Detection of computer virus by antivirus software

Worms:

A worm is a malware that transmits itself over a network to infect other computers.

- i. Worm can be harmful like a virus.
- ii. It spreads automatically in computer networks and replicates itself. It can travel from computer to computer without any human action.
- iii. It enters a computer through a weakness in the operating system of the computer.
- iv. Most of the worms cause some harm to the network such as slowing down communication by increasing network traffic.

Examples of Worms:

Code Red and Fizzer are examples of worms. Code Red worm broke out in July, 2001 and infected about 360,000 computers in a single day. Fizzer is a mass-mailing worm that captures a user's keystrokes and can allow the attacker access to infected computer. Fig shows detection of an e-mailworm by antivirus software.

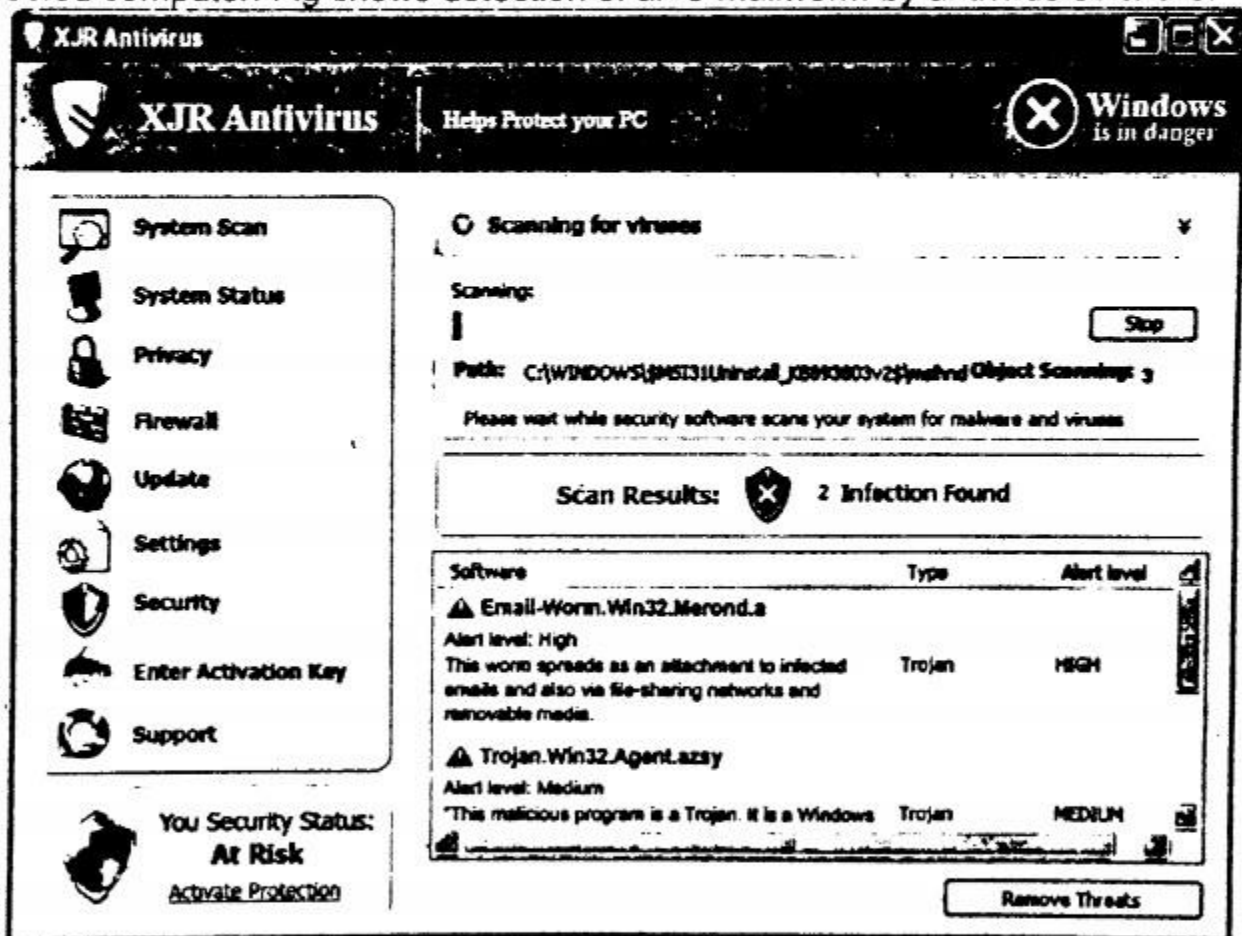

Detection of worm by antivirus software

For Your Information

The first computer virus named 'Brain' was created by two Pakistani brothers, Basit Farooq Alvi and Amjad Farooq Alvi in Lahore in 1986.

Spyware:

Spyware programs are developed to spy on computer users by gathering information about their activities on the computer.

- i. Spyware is developed for the personal benefit of the creator.
- ii. It performs secret operations such as stealing password or banking PIN (Personal Identification Number) or other personal information about user.
- iii. It infects computers through installation of software from Internet.
- iv. It slows down the performance of infected computer.
- v. Most of the spyware is designed to be difficult to remove.

Examples of spyware:

For example, Flame is a spyware that was discovered in 2012. It attacks computers that use Microsoft Windows operating system. It is known as one of the most sophisticated spyware used for the purpose of espionage. It can record screenshots, keyboard activities and network traffic. It also has the capability to turn on the computer microphone and record conversation over Skype.

Detection of spyware by antivirus software is shown in Fig.

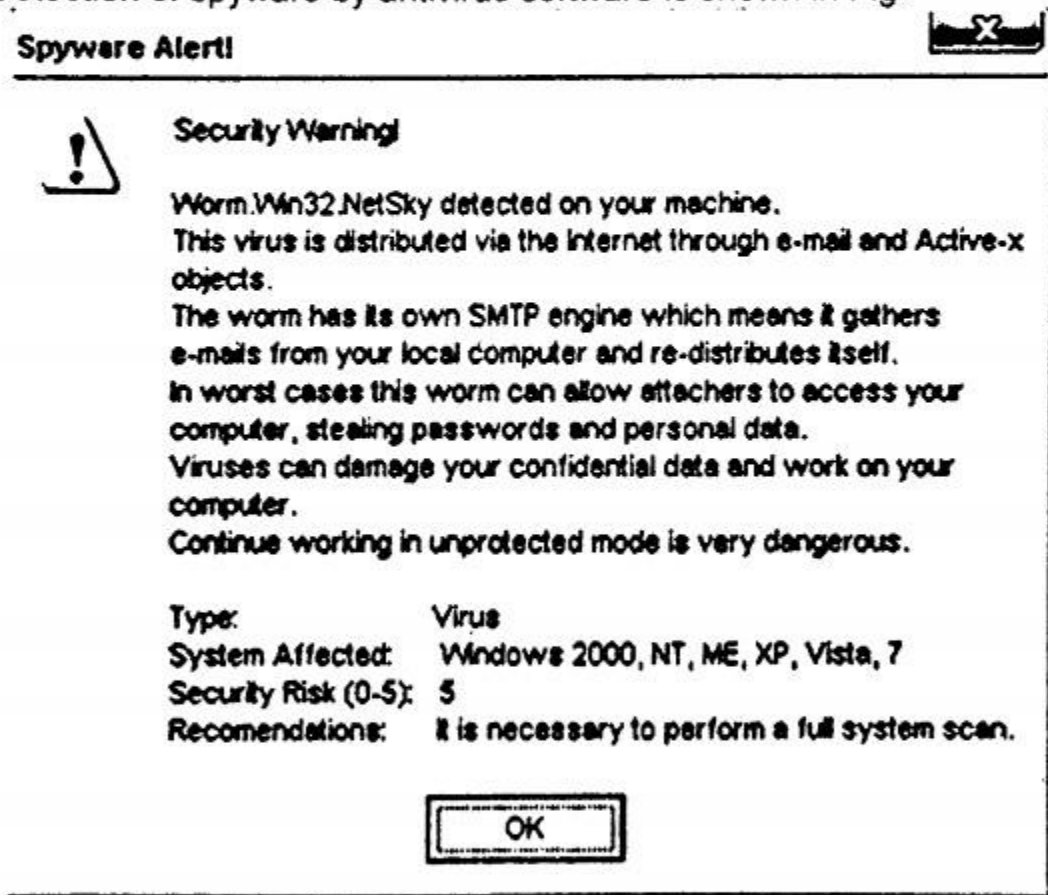

Detection of spyware by antivirus software

Adware:

Adware is a malware that attaches itself to free software on the Internet and infects computer when such software is downloaded.

- i. It pops up advertisements during execution of infected program.
 - ii. Pop-up block option in browsers helps protect computer from adware.
 - iii. Some adware may also collect user information without their permission.
- Detection of adware and other malware are shown in Fig.

Security Suite
Innovative protection for your PC

Perform Scan Performing Scan Current state: Scanning computer

Adjust Setting
Get Updates
Activate Now
Help & Support

Get Full protection with full version

Progress Scanning: 33% completed

C:\WINDOWS\inf\mdmregr.inf Total: 1425

Stop

Malware database status: Out of date (158773)

Malware name	Status	Location
Autorun.AOL	▲ High	Category Worm: It spread...
MoonLight.V	▲ High	Category Worm: Its main...
Emogen.B	▲ Medium	Category Backdoor: It is a...
DisableKey	▲ Medium	Category Adware: Softwar...
Edge Tech	▲ Medium	Category Adware: Softwar...
Win32/NuqeLE	▲ High	Win32/NuqeLE is a worm...
Best search	▲ Medium	Category Adware: Softwar...

Detection of Adware and other malware by antivirus software

ii. Explain how malware spreads.

Ans: Spreading of Malware:

The following are different ways malware can spread in computers.

Infected Flash Drives/CDs:

Virus, spyware and other types of malware can infect computers in which anti-malware software is not installed through infected flash drives and CDs.

Pirated Software:

Software piracy refers to making of unauthorized copies of copyrighted software and distributing it. Pirated software on CDs is a very common source of spreading malware on computers because these are often infected.

If users download pirated music, movies, programs, etc. for free, their computers may be infected because pirated downloads often contain viruses, spyware or other malicious programs.

Network and Internet:

Computers connected to network get infected with malware when information is exchanged with other computers. Computers are also infected while using Internet when users download something or browse infected Web sites.

Computer may get infected with a virus or other malware if the user downloads software such as games, updates, demos and other programs from unreliable sources and installs it on the computer.

E-mail Attachments:

Opening e-mail attachments from a stranger or from an unknown address can infect computer with malware. Even downloading and opening e-mail from a friend or family member can be dangerous. They may pass the user a virus or other malware without knowing about it.

iii. Explain how to protect computer systems from virus attacks.

Ans: Protecting Computer from Malware/Virus Attacks:

We have to install the following software to safeguard computer against viruses, worms, adware and spyware.

- Antivirus software
- Anti-spyware software

Antivirus Software:

Antivirus software is a computer program that detects and removes viruses and other types of malware.

- Computer user should install it on computer and update it regularly.
- Most antivirus programs have an auto-update feature. This feature automatically updates the antivirus program through Internet so that it can detect and remove new versions of viruses as well.
- Whenever a user connects a flash drive or any other type of storage device to computer, he must run it through antivirus software to ensure that it does not contain virus.

Antivirus Programs:

Some commonly used antivirus programs are Norton Antivirus, Kaspersky Antivirus, AVG Antivirus, Bit Defender and McAfee Antivirus.

Anti-Spyware:

Anti-spyware is a computer program that detects spyware infections on computer and removes them. It helps to protect computer against security threats caused by spyware and other types of malware.

- Computer user should install it in computer and regularly update it to safeguard computer against new threats.
- Anti-spyware program runs in the background of computer and continually scans for spyware threats.
- A user can also start Anti-spyware program to scan computer to find and remove spyware.

Anti-spyware programs:

Some commonly used Anti-spyware programs are Norton Anti-spyware, SpySweeper, Spybot-Search & Destroy, Spyware Doctor, and AVG Anti-spyware.

iv. What are the common methodologies used for authentication?

Ans: Authentication Methodologies:

The following are common methodologies used for authentication purpose.

- Username and password
- Personal Identification Number
- Access card
- Biometrics

Username and Password:

A username is a name that identifies a person on a computer system. Username is generally used with a password. The username and password combination is known as login information.

Username and password are used to authorize users to have access to computer systems, e-mail account, bank account and other services available on computer. Username is the known part of user's login information whereas password is secret. If it is known by a person it could be misused with bad intention. Window for entering login information is shown in Fig.

Enter your Login Information Below

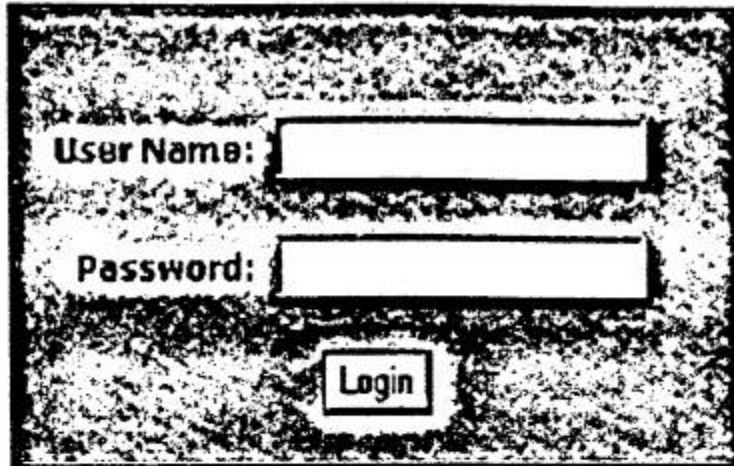
A login form with a dark, textured background. At the top, it says "Enter your Login Information Below". Below this, there are two input fields. The first is labeled "User Name:" and the second is labeled "Password:". Below the password field is a button labeled "Login".

Forgot your Password? [Click Here](#)

Forgot your User Name? [Click Here](#)

Window for entering username and password

Personal Identification Number (PIN):

PIN is a confidential numeric password used to authenticate a user to get access to a computer system. When a user enters the PIN, it is searched in the database stored in the computer. If it matches, the user is authorized to use the computer.

PINS are most commonly used with debit and credit cards in retail stores and many other places for payment of bills. It is also used with ATM cards to withdraw cash from ATM machines as shown in Fig.



Entering PIN on ATM machine

Access Cards:

Access cards are very similar in appearance to credit cards. They do not require username, password or PIN. They are commonly used to open security gates in offices and many other places as shown in Fig, where unauthorized people are not allowed to enter. Access cards are also used to open barriers in parking areas. They are an alternative to key for opening hotel room, etc.

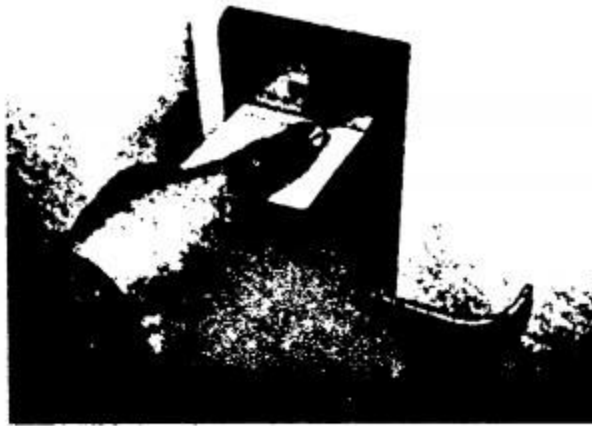

Using access card for opening door of hotel room

Biometrics:

Biometrics refers to authentication methods based on physical characteristics of individuals such as features of face, hand geometry, retina, voice and fingerprint as shown in Fig.



Fingerprint biometrics machine used for time and attendance

It provides highly secure identification and personal verification technologies. Biometrics based systems are used for financial transactions, electronic banking and personal data privacy.

It provides more accurate authentication than using username and password or PIN. Biometrics is associated with a particular individual. Hence, it cannot be borrowed, stolen or forgotten. Forging in biometrics is practically impossible.

v. Define computer ethics and write some important moral guidelines for ethical use of computer technology.

Ans: Computer Ethics:

Computer ethics means an acceptable behavior for using computer technology. It is a code of behavior for moral and social issues while using computer technology, particularly Internet. Computer user should be honest, respect the rights of others on the Internet and obey laws that apply to online behavior.

We should not use bad language while chatting and social networking. We need to respect others views and should not criticize people.

We should not pretend as someone else and fool others. We should not download copyrighted material such as music, movies, etc. People should not do something on the Internet that is morally objectionable or illegal.

Ethical Use of Computer:

The following are some important moral guidelines for ethical use of computer technology.

- i.** Computer should not be used to harm other people.
- ii.** Computer users should not break into others' computer systems to steal, change or destroy information.
- iii.** Computer users should not read documents and e-mails of other users without their consent.
- iv.** People should not make illegal copies of copyright software and sell it for financial benefit.
- v.** Computer users who have special computer knowledge and ability should not create malicious software (such as computer virus) and spread it to other computers.
- vi.** People should not commit any type of crime with the help of computer technology.
- vii.** Computer users should respect the privacy of others.

Lab Activities

Activity:

Students should perform virus scan for hard disk drive of computer, USB flash drive, compact disk, etc. and remove any malware if detected by antivirus software.